

AMHxD3

ON-ROAD/OFF-ROAD NAVIGATION MODULE

USER MANUAL



Introduction

This User Manual provides instructions on how to connect the AMHxD3 On-Road / Off-Road Navigation Module to your Aerpro head unit.

The AMHxD3 has been optimised specifically for selected Aerpro head units. It is also compatible with various aftermarket head units. Refer to the product page on our website for compatibility: aerpro.com/amhxd3

It is important that you follow the connection procedure listed in this User Manual to ensure that you do not have any connection issues with the AMHxD3 and your head unit.

*Your AMHxD3 purchase includes 3 years of basic Hema Maps Cloud account access which provides you access to map downloads and data updates. Please note Data usage over and above the included amount in your Basic Subscription may incur additional charges or restrict access.



CAUTION: Do not use the factory reset in the AMHxD3 settings menu as this will remove Hema Maps and all of your saved information. If you experience any issues with the AMHxD3, disconnect and then reconnect the device from the head unit.

Procedure for AM9X & AM10X

IMPORTANT: You must disconnect any devices currently connected to the head unit before connecting the AMHxD3 to the head unit.

This procedure must be completed each time the AMHxD3 is used:

1. Turn on the head unit in the vehicle.
2. Touch the  icon to access the 'Devices Connected' screen.
3. Disconnect any devices currently connected to the head unit by simply tapping the highlighted (coloured) icons to toggle them off (see image below).

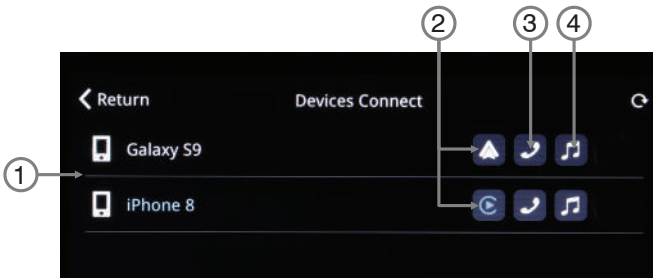

- | | |
|------------------------------|--------------------|
| 1. Connected device | 3. Bluetooth phone |
| 2. Android Auto/CarPlay icon | 4. Bluetooth music |

4. Connect the AMHxD3 to the USB port labelled 'CarPlay / Android Auto' on the rear of the Aerpro head unit.

5. The AMHxD3 will automatically power on and you will be presented with the home screen (refer page 8 User Interface).

6. For first time connection to the AMHxD3, navigate to your phones Bluetooth settings and select AMHxD3 (refer page 5). Your phone will now automatically connect the AMHxD3 the next time you plug the device into the head unit, as long as you have followed this procedure.

Procedure for other headunits

IMPORTANT: You must disconnect any devices currently connected to the head unit before connecting the AMHXD3 to the head unit. These steps will vary depending on the type of head unit currently installed in your vehicle. This procedure is to be used as a reference only.

This procedure must be completed each time the AMHXD3 is used:

1. Turn on the head unit in the vehicle.
2. Navigate to your head units settings.
3. Tap on the Bluetooth connectivity settings.
4. Disconnect from any devices that are currently connected to your headunit.
5. Connect the AMHXD3 to the USB port labelled 'CarPlay / Android Auto' on the head unit. (Type C adapter may be required, see page 6).
6. The AMHXD3 will automatically power on and a calibration screen may appear if this is the first time it's being used on your head unit. The device will restart automatically once completed and show the home screen (refer page 8 User Interface).
7. For first time connection to the AMHXD3, navigate to your phones Bluetooth settings and select AMHXD3 (refer page 5). Your phone will now automatically connect the AMHXD3 the next time you plug the device into the head unit, as long as you have followed this procedure.



NOTE: Images used as reference only, your headunit will look different.

Procedure continued

Apple Devices

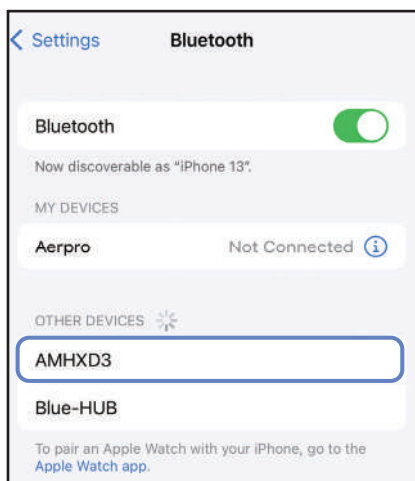

Android Devices

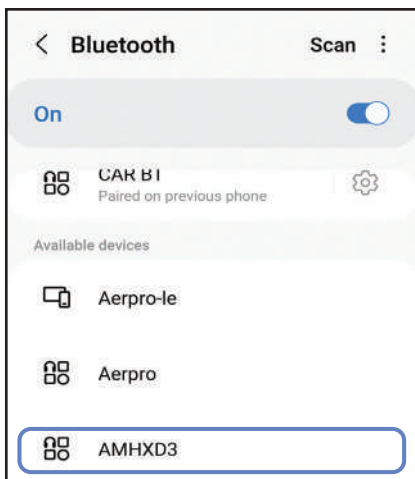

INTERFACE

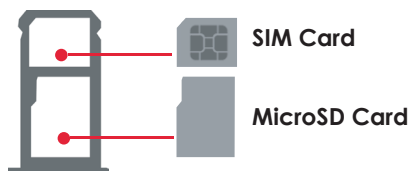
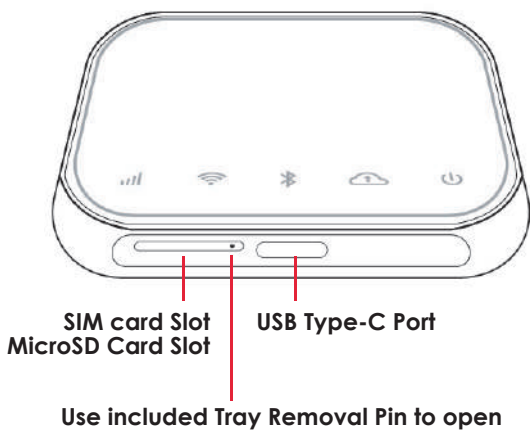

Note: If your vehicle uses a TYPE-C connection, use the included adapter (See picture)

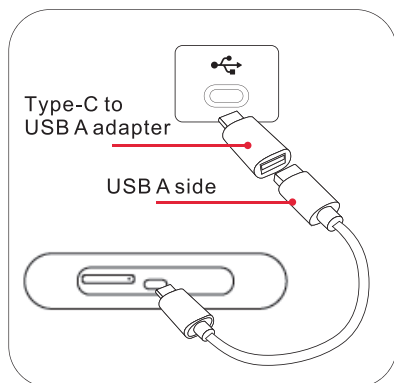

LED Indicators

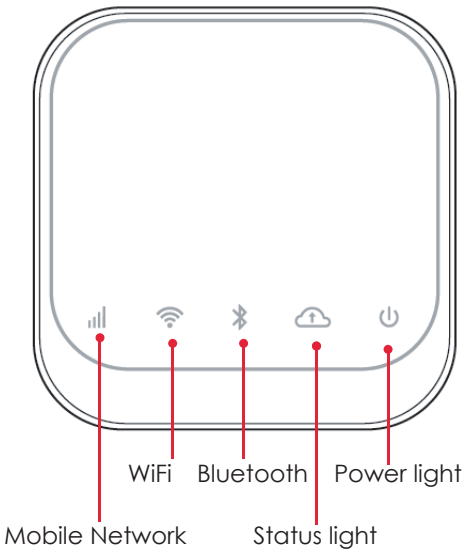

The LED indicator lights will illuminate when in active.

Power light stays on when powered.

Status light flashing indicates the device is working.

AMHxD3 User Interface



1. Hema HxD3 App
2. HxD3 Updater
3. Assistive Touch Bar (Home/Back/Exit)

4. Exit to Headunit
5. Show Apps
6. Recently used Apps
7. Connectivity

Hema Maps AMHxD3 Module

The Hema Maps application provides offline Turn By Turn Navigation and Off Road mapping, additional functionality and map updates are available when connecting your AMHxD3 to the internet.

Connecting To Wi-Fi

Note: A network connection is required in order to use network features etc. (Connecting to the internet via Wi-Fi or Mobile Data using a sim card, the time and date should automatically sync with the internet).

1. Tap Settings icon
2. Navigate to 'Network & Internet'
3. Tap 'Wi-Fi'
4. Choose a Wi-Fi name and input your password to connect to your Wi-Fi network.

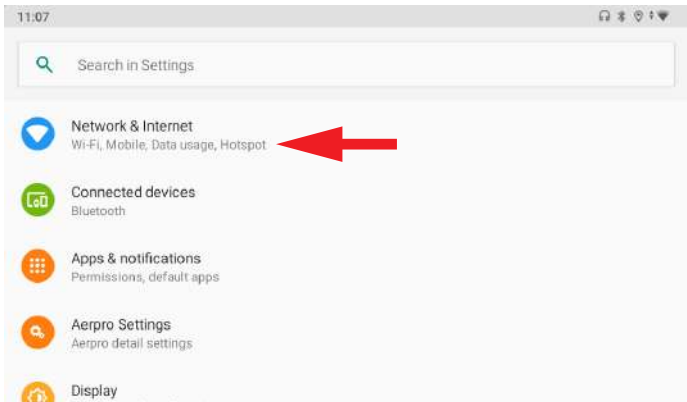
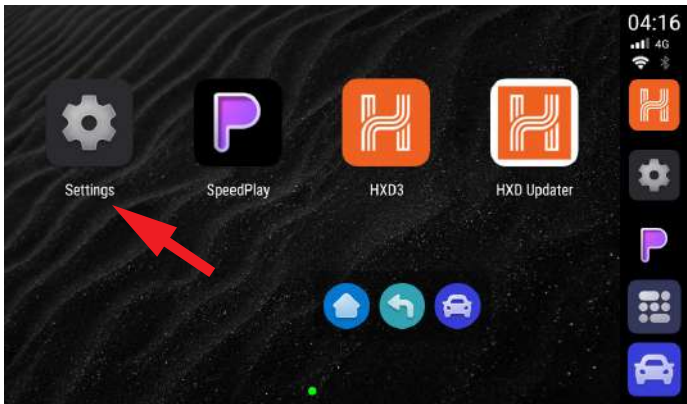

Connecting To Wi-Fi continued

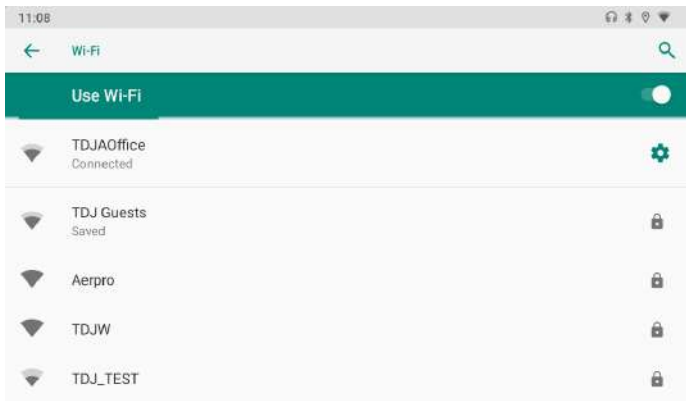
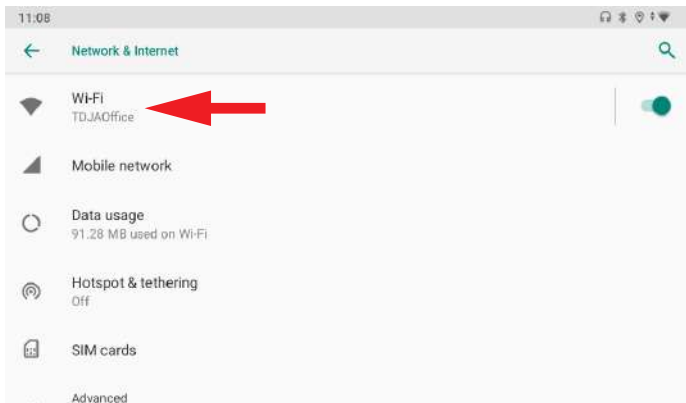

Updating Hema Maps software Using HXD updater

Internet connection required to receive software updates

1. If a Hema Maps software update is made available for your AMHXD3 you will be presented with a pop up dialog asking if you would like to update your software. Clicking OK will bring you to the HXD Updater. You can also tap the Updater icon in the Hema Home screen or the HXD Updater application on the AMHXD3 Home screen
2. If this is the first time you have updated the software you will be presented with an option to go to the settings to allow the HXD Updater to install apps. (This option will only need to be done once)
3. Enable 'Allow from this source' then press the back button in the top left corner
4. Then you can continue the installation by clicking install.
5. Once completed you will be presented with the option to either open the app or tap done and return to the previous screen.

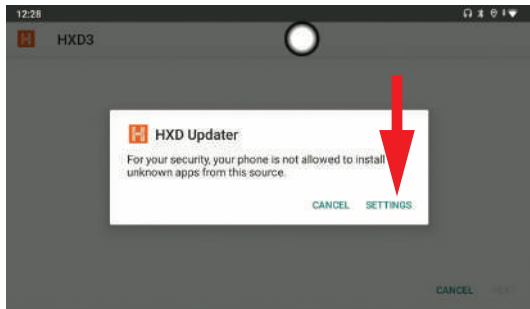
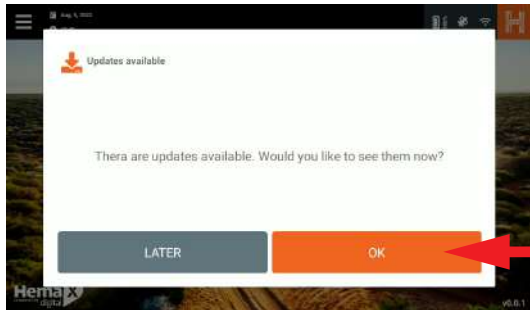

Updating Hema Maps software

Using HXD updater continued

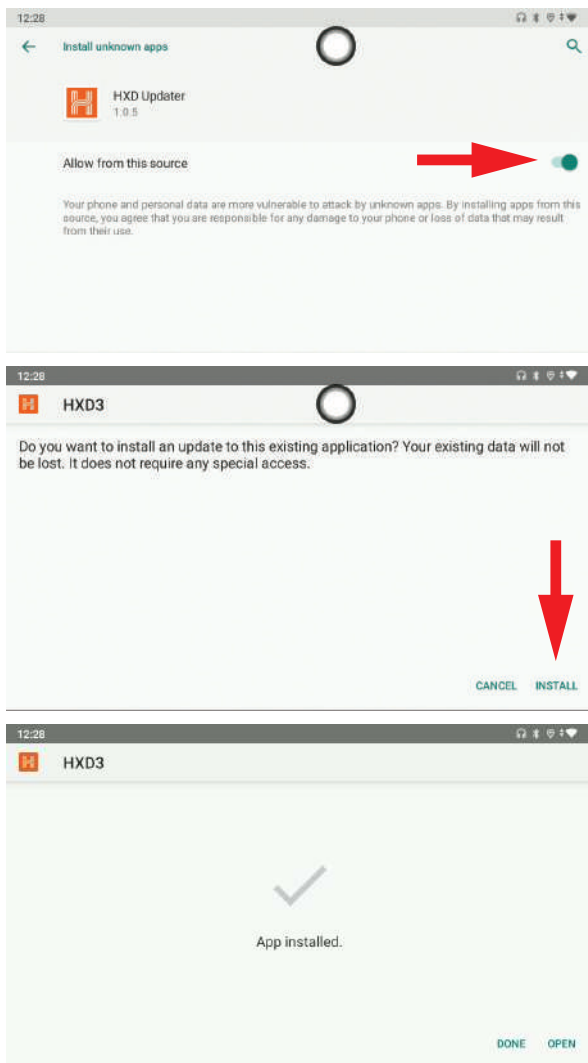

Adjusting Date/Time

Note: You will only need to do this if you do not have an internet connection and the date & time is incorrect.

1. Tap the 'Settings' icon in the home screen
2. Navigate to the bottom of the settings page and tap 'System'
3. Tap 'Date & time'
4. Turn off 'Automatic date & time' in order to manually set the date and time of your AMHXD3.

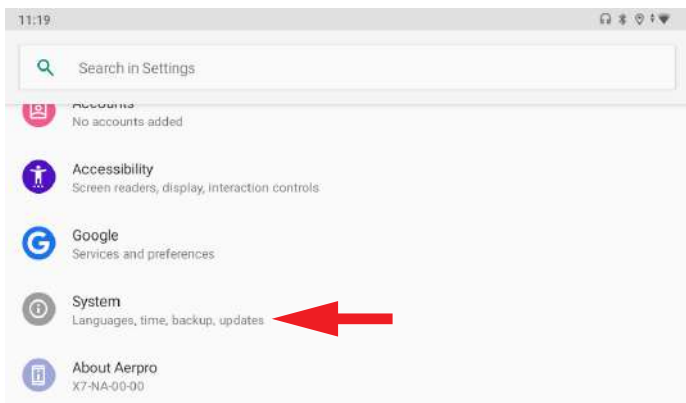
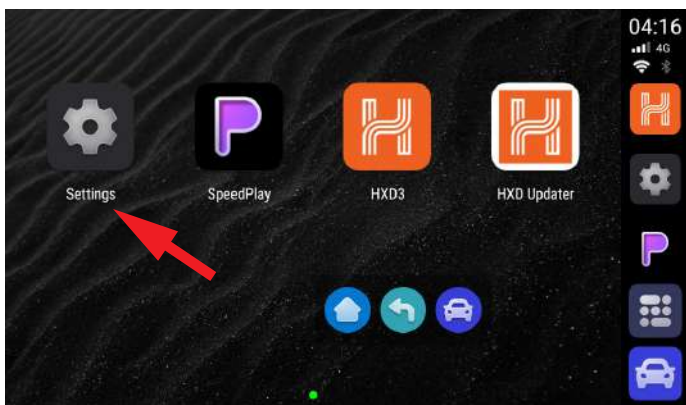

Adjusting Date/Time continued

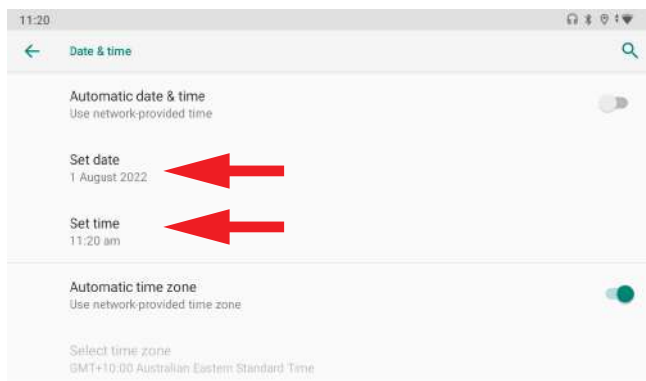
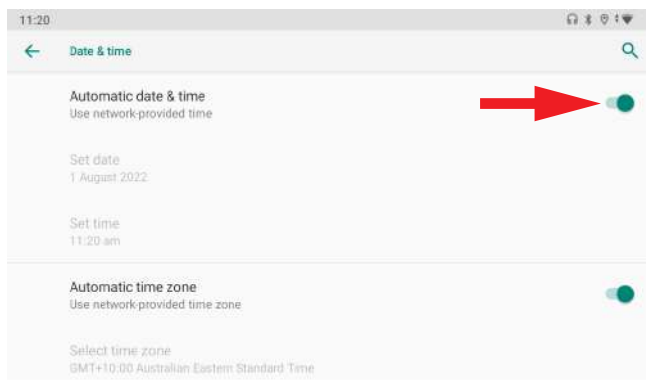
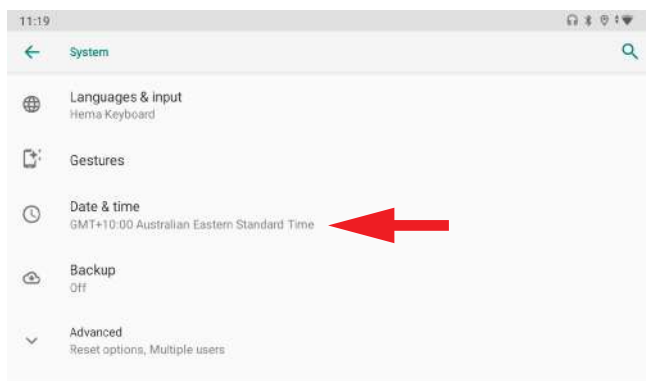

Bootup APP

Note: This setting allows you to select an application that will start up automatically when the device boots. If you would like to automatically open Hema Maps on boot up follow the steps below.

1. Tap 'Settings' icon on the home screen
2. Navigate to the 'Aerpro' Settings section
3. Scroll down and tap 'Bootup App'
4. Scroll down until you see 'HXD3' and select it.

Now, when the AMHXD3 restarts, the device will automatically start Hema Maps on vehicle startup.

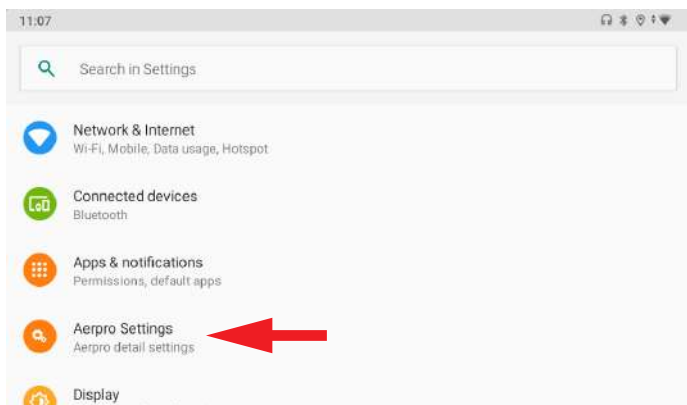
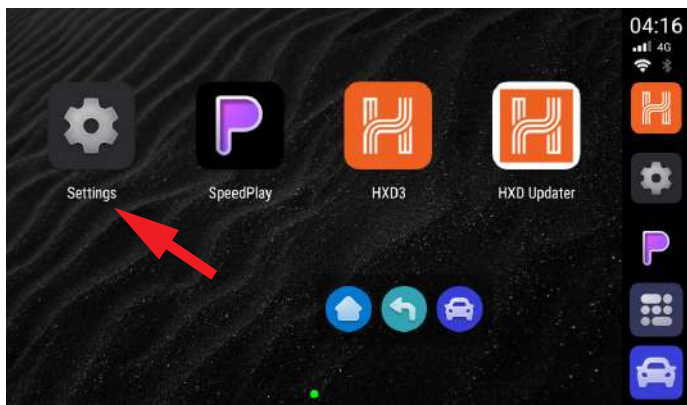

Bootup APP continued

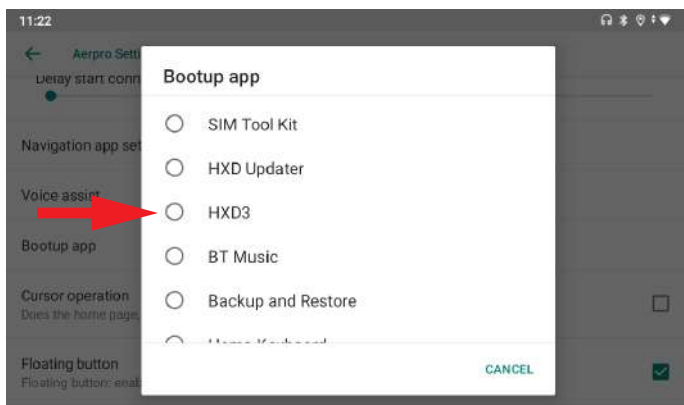
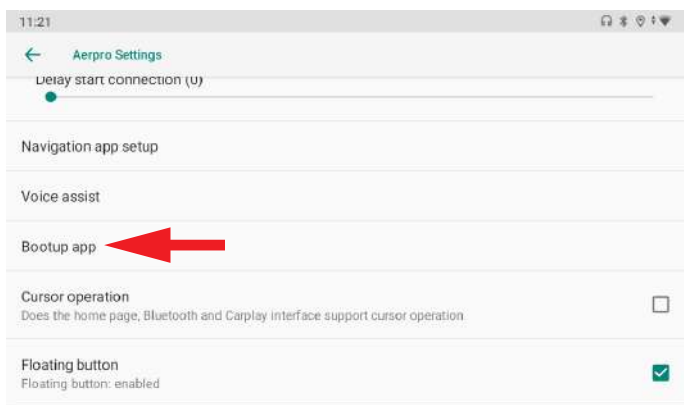

What's Included

- AMHXD3 Hema Maps Add-on Module *(Includes 1 x Basic Hema Maps Cloud account subscription, refer page 2*)
- Type C to Type A USB Cable
- USB 3.1 Gen 1 Type C to Female Type A USB Adapter
- Micro SD/SIM Card Tray Removal Pin
- Quick Start Guide

Specifications



Memory: 4GB RAM + 64GB ROM



Internal Storage: 64GB Internal Storage



Expandable Memory: Micro SD card (up to 128GB)



SIM Card Support:

4G LTE-FDD & LTE-TDD (Band 1/ 3/5/7/8/20/28/38/40/41)



WiFi: 802.11a/b/g/n/ac 2.4Ghz & 5Ghz Dual-Band



Power Input: USB 5V



GNSS: Built-in GPS, GLONASS, Beidou



Operating Temperature: -30-75°C



Dimensions: 82*80*14.5 mm



Weight: 74g

Technical Assistance

If you need assistance setting up or using your Aerpro product now or in the future, call Aerpro Support Australia TEL: 03 – 8587 8898
FAX: 03 – 8587 8866
Mon-Fri 9am – 5pm AEST

This manual is considered correct at time of publishing but is subject to change. For latest manuals and updates refer to the website.

Please download the latest manual for the AMHxD3 from the Aerpro website or scan the QR code below for product information and video guides.

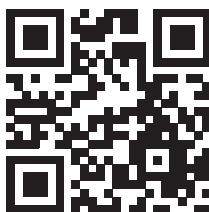

AERPRO.COM



© Hema Maps 2022. Copyright. Hema Maps® is a trademark of Hema Maps PTY LTD.

HERE® is a trademark of Here Technologies LLC.

Apple and Apple CarPlay are trademarks of Apple Inc., registered in the U.S. and other countries.

Android Auto is a trademark of Google Inc.

Other trademarks and trade names are those of their respective owners.

Design and specifications are subject to change without notice.

Use of the Hema Maps Software and Hema Maps Cloud on this device are subject to terms, conditions and licence agreements. For full details, please refer to the AMHxD3 Hema User Manual which can be found in this document.



AMHXD3

HEMA MAPS USER GUIDE



hemamaps.com

Welcome

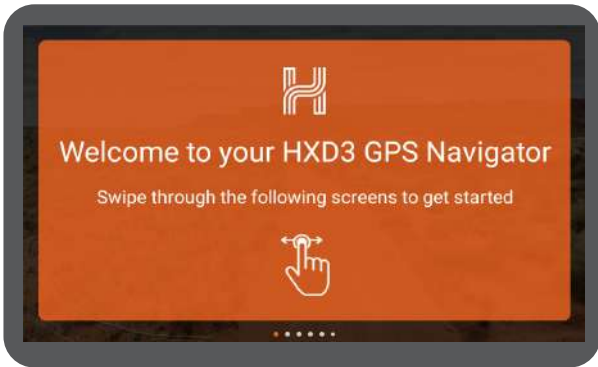

Registering your AMHXD3: The first time you switch on your AMHXD3 you will be guided through the setup process by a setup wizard. This will help connect your AMHXD3 to the Internet and allow you to sign in to or create your Hema Cloud account.

The Hema Cloud account grants you access to connect your AMHXD3 to the cloud.hemamaps.com services including trip planning, track recording, personalised waypoints & POIs and syncing your information across multiple devices.

Important: The AMHXD3 does need an initial Internet connection to set the correct date and time to register.

Signing in from your AMHXD3

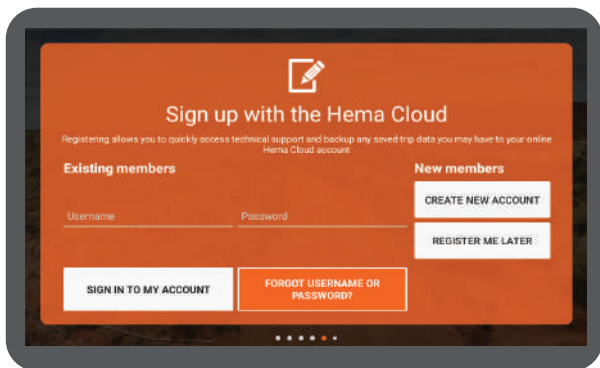

It is highly recommended you sign into your AMHXD3 via a registered Hema Cloud account, as signing in will allow you to receive regular updates and support for your AMHXD3, to back up and share trip data, and to unlock premium map content and navigation features available to you.

If you choose to not register your AMHXD3 with a Hema Cloud account, you will not have access to synchronise your recorded tracks or saved trips across your devices. You will also restrict your access to premium map and content updates available through your Hema Cloud account.

NOTE: 1) By signing up for a Hema Cloud account you are accepting the AMHXD3 and Hema Cloud account terms and conditions and the Hema Maps Pty Ltd Privacy Policy
2) You can initiate the setup process again from the tutorial menu at any time in order to register a new Hema Cloud account or you can login using existing Hema Cloud account credentials.
3) An existing HX-1 Explorer account is not compatible with the AMHXD3. You will need to transfer your Explorer account to the new Hema Cloud account via <https://cloud.hemamaps.com/migrate/start>

The main screen

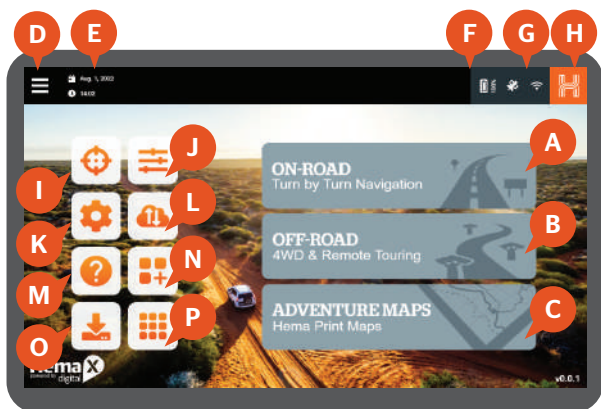

- (A) ON-ROAD - Turn by Turn Navigation
- (B) OFF-ROAD - 4WD & Remote Touring
- (C) ADVENTURE MAPS - Hema Print Maps*
- (D) Drop down menu including trips, tracks, routes
- (E) Date and time
- (F) Battery indicator
- (G) Wi-Fi indicator
- (H) Navigation button
- (I) My location
- (J) App Settings
- (K) Device Settings
- (L) Data Sync
- (M) Quick Start Guide
- (N) Customise Home Buttons
- (O) Updater
- (P) All Apps

Important: The AMHXD3 has three primary functions; ON-ROAD for turn by turn street navigation (ideal for urban driving), OFF-ROAD designed for remote and 4WD exploration and ADVENTURE MAPS* granting access to Hema's catalogue of iconic Australian print maps. *Adventure Maps is not included in the the Basic Hema Maps Cloud account subscription provided with the purchase of this product. Refer to p2 of the AMHXD3 user manual.

ON-ROAD

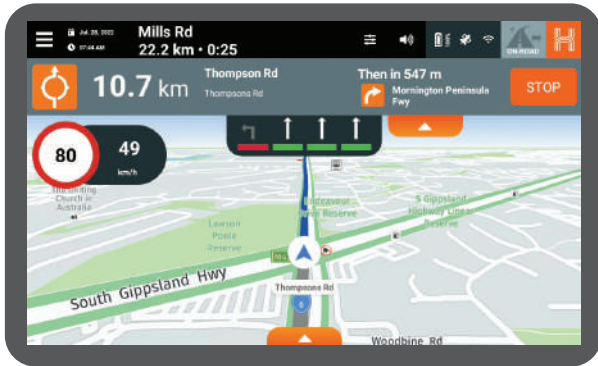

The AMHXD3 On-Road function provides detailed navigation, primarily for on-road / urban driving, and is powered by the HERE Technologies - the global leader in in-car navigation.

ON-ROAD continued

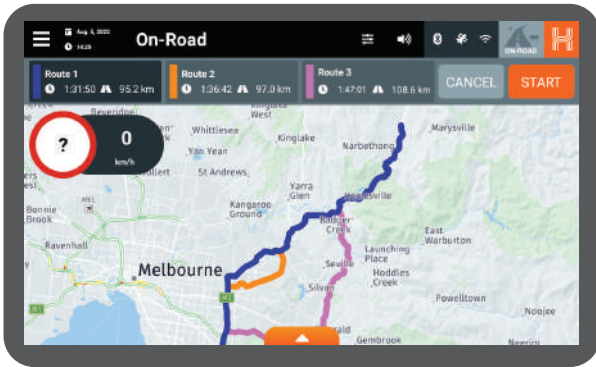

The On-Road platform provides:

- Detailed turn-by-turn navigation
- Voice and display guidance
- Multi Route Options
- Speed Alerts
- Integrated POI search
- Location / Street Address search
- Web location search (online only)
- Track Recording
- Trip / Location status bar
- Live traffic alerts (requires Internet connection)
- Hema POIs overlaid

OFF-ROAD

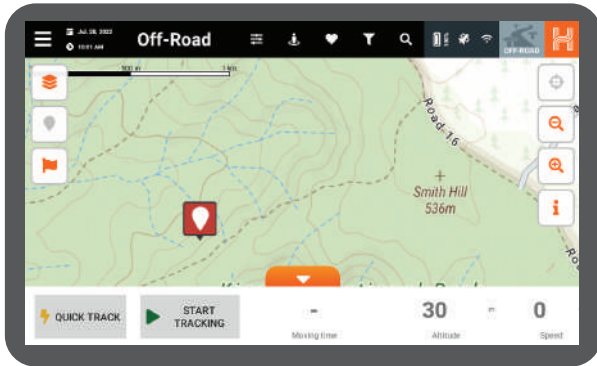

The AMHXD3 Off-Road function is the centrepiece of the AMHXD3 which includes the new Hema Explorer Digital Map and leverages core functionality of the new Hema Cloud to sync tracks and other data.

The Off-Road system is designed to aid users to navigate in remote and off-road locations by leveraging the detail and styling of the Hema Explorer Map.

The AMHXD3 Off-Road function includes:

- Online / Offline Hema Explorer Digital Map
- Multiple Map Layers (including Satellite / Hybrid - online only)
- 100,000+ Points of Interest (including Hema Maps verified POIs and 4WD tracks)
- Search tracks, trips and favourite locations
- Full track recording capability
- Navigate to Location
- Follow pre-existing tracks
- Load featured tracks
- Tilt / rotate Map
- Map centre, Map lock and zoom

ADVENTURE MAPS

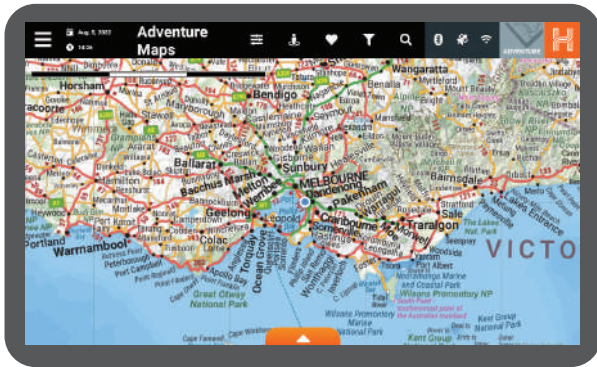

The AMHXD3 Adventure Maps* brings to life the Hema Maps print maps to give users the ability to view the highly detailed maps of Australia. The static nature of the Adventure Maps allows users to retain context for the local surroundings plus detailed navigation / location information for these remote areas.

The Adventure Maps function includes:

- Hema Print Maps including Iconic Map Series, Regional / Remote Maps, State Maps, Australia wide maps
- Ability to display other map layers (via subscription)
- Ability to overlay the AMHXD3 Points of Interest
- Full track recording capability
- Navigate to Location
- Map centre, Map lock and zoom

Important: *Adventure Maps is not included in the the Basic Hema Maps Cloud account subscription provided with the purchase of this product.
Refer to p2 of the AMHXD3 user manual.

Hema cloud account

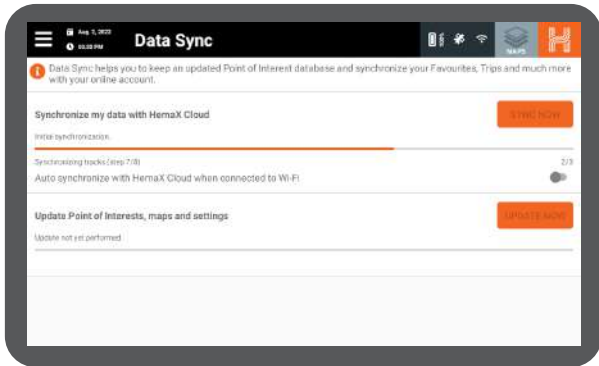
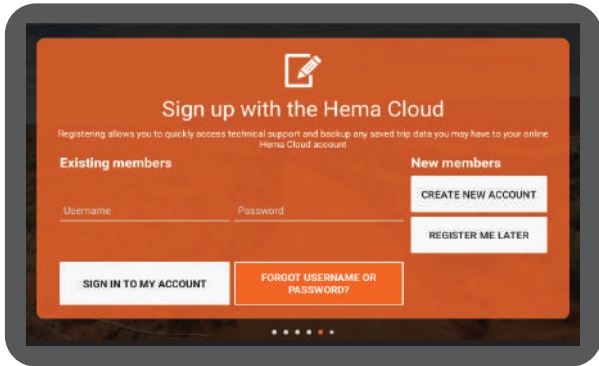

The Hema Cloud is account management system that maintains all your AMHXD3 information in the “cloud” and allows you to update and synchronise the information to make the most of your AMHXD3.

The Hema Cloud stores your information in secure manner and allows you to save, store and share information that you create across all Hema Cloud products.

Hema cloud account continued

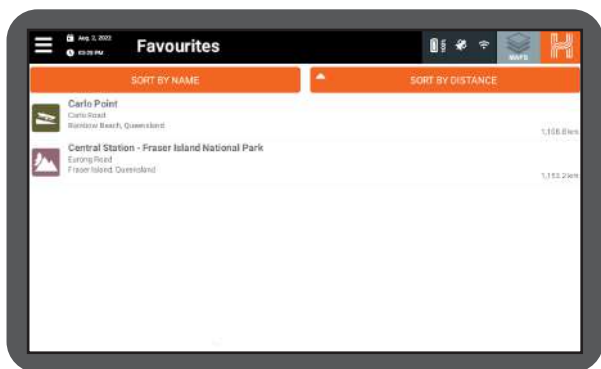
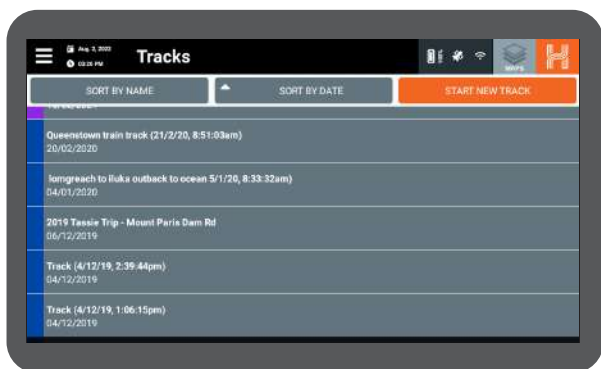

Hema cloud account continued

The Hema Cloud functionality on the AMHXD3 includes:

- Sync your data across all your Hema Cloud products including:
- AMHXD3
- 4x4 Explorer
- Hema Maps Cloud (cloud.hemamaps.com)
- HX-2

The Hema Cloud also provides the ability for you to transfer your old tracks, waypoints and photos from the old Explorer Cloud to ensure you can keep all your journeys in one place.

The Hema Cloud functionality on the AMHXD3 includes:

- Download Featured Tracks
- Manage your subscription
- Set preferences
- Save and export trip plans / track recording across your devices
- Create your own favourite lists and personal waypoints / POIs
- Unlock premium subscription options across other platforms
- Stay up to date with latest news and product information
- Update map packs / software releases / premium features
- Register your devices

Important: The Hema Cloud information stores your personal information in accordance with the Hema Maps Pty Ltd Privacy Policy and the Hema Cloud Terms and Conditions.

GPS Screens & Location Services

GPS Screens & Location Services

The AMHXD3 has a number of features which allow you to validate your current GPS signal(s) and detail your current location.

The Satellite Status provides the status and the details of the Satellites that the AMHXD3 has a fix on.



ID	C/N0 (dB-Hz)	Fix	Azimuth °	Elevation °
26	20.9	✓	241°	23°
15	19.8	✓	231°	8°
14	19.7	✓	280°	16°
22	13.7	✓	306°	52°
195	0	✗	201°	77°
29	0	✗	116°	74°
129	0	✗	333°	55°
20	0	✗	295°	53°
18	0	✗	216°	47°
15	0	✗	66°	44°
193	0	✗	339°	36°
194	0	✗	345°	30°
25	0	✗	344°	29°

The My Location page provides specific information for your AMHXD3's current location, including but not limited to:

- Sunrise & Sunset
- Decimal / DMS coordinates
- Street Address
- Elevation
- What 3 Words location

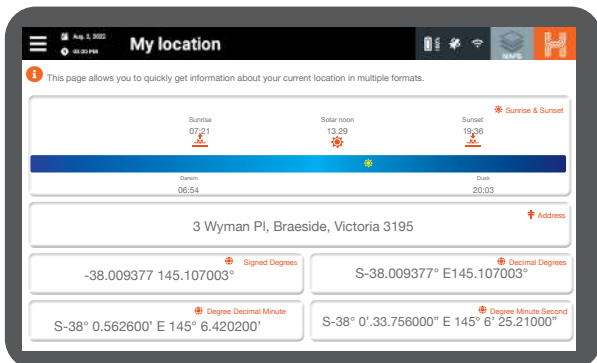

This page allows you to quickly get information about your current location in multiple formats.

Sunrise 07:21 Solar noon 13:29 Sunset 19:36

06:54 20:03

3 Wyman Pl, Braeside, Victoria 3195

-38.009377 145.107003° S-38.009377° E145.107003°

S-38° 0.562600' E 145° 6.420200' S-38° 0'.33.756000" E 145° 6' 25.21000"

Other Functions, Settings & help



From the Navigation panel you can:



Pressing the Navigation button allows you to return you to the previous screen you were on. If you hold the H down for 2 seconds it will take you back to the Home Screen



My Location provides you a complete picture of where you are currently located including GPS co-ordinates, What 3 Words and GPS coordinates



Customise Home Buttons allows the user to arrange or replace the home buttons by dragging icons to your preferred position

Other Functions, Settings & help



Device Settings

Tapping the Settings button will allow you to make system changes (e.g... set date and time), manage Bluetooth and Wi-Fi connectivity. Device Settings: access all the AMHxD3 Operating System settings.



Data Sync

Quick access to the data sync module which allows users to update their map data packs.



Help

The Help button will launch the AMHxD3's quick start guide manuals. Here you can find information needed to fully operate your Hema AMHxD3 Navigator and links to more information.



All Apps

Displays all available Apps



Updater

The updater allows you to update the core AMHxD3 systems over Wi-Fi and pick up map updates.



App settings

Quick link to access the settings for the Hema AMHxD3 product.

AMHXD3 TERMS AND CONDITIONS OF USE

The following are the Terms and Conditions of Use of the Hema Software. Please read these Terms and Conditions carefully. If You use the Hema Software, You will be bound by these Terms & Conditions of Use. The Hema Software (“the Software”) is licensed, not sold, to You for use only under the terms of this license. It contains warranty and liability disclaimers which You should read.

The Software and the Data are copyrighted works, protected by law, violation of which may result in civil or criminal liability. Access to the Software requires you to have internet access. Internet services may not be available at your present or intended location or may be very expensive.

1. Scope of Licence granted

1. Subject to the usage rules and restrictions in clauses 2 and 3, we grant You a non-exclusive, non-transferable license to:

- a. Use the AMHXD3 licence and Software thereon;
- b. Backup the Software and Your Data from any device that You own to the Hema Cloud or to any personal computer or device that You use, to keep for Your use. You must not give the backup or copy to anyone else and any such backup or copy is governed by these Terms and Conditions.

2. Usage Rules

1. Always be prepared, drive carefully and travel responsibly. Location data and road conditions are constantly changing, and the Software may contain errors, omissions or inaccuracies. Location data or navigational information is provided as a general guide only and is not intended to be relied upon as a sole means of navigation or in situations where precise location information is needed, or where erroneous, inaccurate or incomplete data may lead to death, personal injury, property or environmental damage. You must make Your own enquiries in relation to conditions and the availability of fuel, drinking water, supplies and services. Depiction of a road or track in the Software is not an assurance of safety or manner of passage or public right of way and information contained in the Software does not replace traffic signs, lights, road markings, speed limits and other road rules.
2. You must take care of Your own personal safety, and (if applicable) obey the road rules, at all times. Do not operate the Software while driving. Do not use or operate any mode of transport or attempt any journey while under the influence of alcohol or other substances.
3. You acknowledge that the Content within the Software is for planning purposes only and You should make Your own enquiries and exercise Your own judgment in relation to weather conditions, construction, road closures or other events that may impact on the journey You are undertaking.
4. You acknowledge that some content within the Software is protected by applicable intellectual property and other laws, including but not limited to copyright, and that You will not use such proprietary content in any way whatsoever except for permitted use under these Terms and Conditions. You also acknowledge that some content may be provided

under licence from third party providers and this content is subject to the same intellectual property laws.

5. The Software may enable access to Hema Maps and other third party maps, content, services and web sites (such as HERE maps, Map box, weather data and the Hema Cloud). If these are provided, they are done so solely as a convenience to You and may be withdrawn at any time. Access to these services may require internet access, which You will need to arrange and pay for. Internet services may not be available at Your location or may be very expensive. Because of the nature of the internet, it is possible that these sites may contain computer viruses or material which You may find offensive. Hema Maps does not warrant or endorse, and disclaims liability to You or any other person, for any third party maps, content, services, and web sites. Hema Maps reserves the right to change content or options (including eligibility for particular features) without notice.

6. The provision and terms of use of the Hema Cloud will be subject to the Hema Cloud EULA as amended from time to time and may be subject to restrictions on use, content and size as Hema Maps shall determine in its sole discretion.

3. Services provided by Hema Maps

1. Hema Maps reserves the right to outsource the provision of services to third-parties where it is necessary including the provision of Hema Cloud Services.

2. You agree that the form and nature of the Hema Software may change from time to time without prior notice being given to You.

3. Hema Maps reserves the right to change, suspend, remove or disable access to any of the services contained in the AMHxD3 at any time without notice.

4. Hema Maps may also impose limits on the use of or access to the Hema Cloud Services from within the Software.

4. Licence restrictions

1. This license does not permit You, and You agree that You will not (except where we give our express written consent or You are expressly permitted by law to):

- a. commercialise, or attempt to commercialise, or derive any monetary reward or commercial benefit (whether a fee is charged for it or not) from the use or sale of the Software, the Data or user data (including any Data You or other users have created or stored in the Software or Hema Cloud or any part of it (including but not limited to any location data or other geographical information contained in, or copied or obtained from, the Software whether modified or not). This includes but is not limited to supplying part or all of the content into an open source or not for profit database e.g.. crowd-sourcing, open street map;
- b. use the Software on any other device. You will not distribute or make the Software available over a network where it could be used by multiple devices at the same time;
- c. digitise or edit the Software or take a digital or analogue image, photograph or screenshot of the Software, other than for the

- d. remove, obscure or interfere with any copyright notice, trade mark, warning or disclaimer contained in the Software;
 - e. use all or any part of the Data to make a map, guide, publication, website, navigational aid or publication for the purpose of supply to others for commercial benefit or promotion, whether a fee is charged for it or not;
 - f. transfer, give, assign, rent, lease, sell, charge, exchange, adapt, decompile, disassemble, create a derivative product or otherwise deal with the Software other than in the normal course of use, and subject to this to these Terms & Conditions, as amended from time to time;
 - g. reproduce in any way, copy or extract the Software or the Data, in whole or in part and give, sell, rent, market or distribute it to anyone else;
 - h. copy the Software or any data stored in the Hema Cloud onto another storage device other than as expressly permitted by clause 1 sub clause 1 section (b);
 - i. without limiting any of the paragraphs (e) to (h) above, copy, or attempt to copy, the location data, maps points/places of interest (POI's), names, places, symbols, road markings, layout or other geographical information contained in the Software, or use such information or data as a reference to make any other product, or otherwise extract, reverse engineer, decompile, modify, disassemble, attempt to derive the source code of, modify, or create or attempt to create a new or derivative works of or from the Software;
 - j. use the Software in a manner contrary to any agreement You have with any third party;
 - k. sub license or assign Your rights under this license to anyone.
2. You acknowledge that the Software and its contents, including the Data, contain valuable intellectual property. We may impose further restrictions on Your use of the Software or the Data at any time, as we deem to be reasonably necessary to protect our intellectual property rights, by the giving of notice to You.
3. The Software is protected by copyright law and international treaties. Unauthorised reproduction or distribution of this Software, or any portion of it, may result in severe criminal and civil penalties and will be prosecuted to the maximum extent possible under law.

5. Ownership

Subject to this clause 5:

1. Hema Maps expressly reserves all copyright and any other intellectual property rights to the Software, the Data, including (without limitation) places of interest (POIs), and any or all maps created or published by Hema Maps, and the Hema Cloud and only grants You a limited licence to use the Software and the data in the manner permitted by these Terms & Conditions.
2. Other than as specified herein, You agree that Hema Maps owns the intellectual property rights to the Data, whether in its original form or as modified, printed and/or copied by You.
3. Subject to clauses 5 sub-clause 1 and clause 5 sub-clause 2 above, You own the content (excluding the Data in its original or modified form) that You create using the Software (e.g. Your photographs). However,

You grant us a non exclusive, perpetual, transferable, sub-licensable, royalty-free, worldwide license to use any IP content that You input or generate by using the Software, including (but not limited to) reviews, comments, photos, places of interest, tracks, way points, or other personal information or by-products of the Software.

4. HERE North America LLC is the publisher of the base data used under licence for the Street, Terrain and Satellite Maps and is the owner of the intellectual property rights within, which are used in the product under licence.

5. You acknowledge that Hema Maps is the sole owner and user of the Trademarks, name(s) or words Hema, Hema Maps, Hema Navigator, HemaX, Hema GPS, Hema 4WD Explorer, Hema Navigator Explorer, Hema Explorer, Map Patrol, "Hema Maps will get You there", and "Prepared to Explore." the Hema corporate logo and the Hema "H" icon and You must not use our names or trademarks without our express written permission.

8. This product includes Here Maps SDK provided by HERE North America LLC and the Map box SDK provided by Map box.

9. Contains information licenced from Open Street Maps, Geoscience Australia, Camps Australia Wide, Landgate (Western Australian Land Information Authority) and other State Government bodies.

10. Hema Maps may add other licenced software from time to time.

6. Limited warranties

Save to the extent prohibited by law:

1. while the Software has been produced and supplied in good faith, Hema Maps makes no warranty or representation about the availability, accuracy, completeness, reliability or currency of the Software or the location data contained therein;

2. the Software and the Data is provided "as is" and "as available", with all faults and without warranty of any kind. Hema Maps disclaims all other warranties, either express or implied, including warranties of merchantability, fitness for purpose or for a particular purpose and non-infringement of third party rights unless such warranties cannot be excluded by law. Hema Maps does not warrant against interference with Your enjoyment of the Software, that the Software will meet Your requirements or that the operations of the Software itself or in conjunction with other products will be uninterrupted or error free.

3. You expressly acknowledge and agree that use of the Software is at Your sole risk and that the entire risk as to suitability, satisfactory quality, reliability, performance, accuracy and effort is with You;

4. although Hema Maps or a third party may provide technical support, Hema Maps does not warrant that technical support will be provided for the Software;

5. no oral or written information or advice given by Hema Maps, agents or employees shall create or extend existing warrants. You must not rely on any such information or advice unless in writing and signed by an authorised representative of Hema Maps.

6. For the absence of doubt, your statutory rights remain valid and in force and, in the event of inconsistency between these Terms and Conditions and your statutory rights, your statutory rights prevail to the extent of the inconsistency.

7. Limitation of liability

1. This Software displays, includes or makes available content, data, information, applications collected by or supplied by third parties, which may contain errors, omissions, inaccuracies or faults. By using the Software, You acknowledge and agree that Hema Maps is not responsible for examining or evaluating the content, quality, currency, accuracy, completeness, legality, or any other aspect of such third party data.
2. You use and rely on the Software entirely at Your own risk and should not solely rely on the results or information obtained from the Software for any purpose, including navigation.
3. To the extent not prohibited by law, the liability of Hema Maps for any breach of an express, statutory or implied warranty shall be limited, at its option, to the cost of replacement of the Software or a refund of the price paid by You.
4. To the extent not prohibited by law, Hema Maps shall not be liable for any loss or damage to person or property, or any incidental, special, indirect or consequential damages whatsoever, including without limitation, loss of income, loss of revenue, trade, business, information or profits or any other loss arising from the installation or use of the Software or reliance upon any Data (irrespective of whether or not the Data is used in any navigation system or for the purposes of navigation) whether based on breach of contract, tort (including negligence), product liability or otherwise.
5. Hema Maps shall not be liable for any information, advice or technical support given by a third party unless in writing and signed by an authorised representative of Hema Maps.
6. It is Your responsibility to update the Software with the updates provided by Hema Maps from time to time. Hema Maps shall not be liable for Your reliance or use of an out of date version of the Software.

8. General

1. This agreement incorporates the terms of the Hema Cloud EULA (as amended from time to time). It otherwise makes up the entire agreement between the parties regarding the Software, and supersedes any prior agreements.
2. This agreement incorporates the terms of the HERE Maps End User Terms and the Map box End User Terms, as amended from time to time.
3. If any portion of this agreement, or the incorporated agreement(s), is found to be unenforceable, the remaining portion will remain in full force and effect.
4. If Hema Maps fails to enforce any terms of this agreement, this will not constitute a waiver.
5. These Terms and Conditions ("this agreement") shall be governed by and interpreted in accordance with the laws of the State of Queensland, Australia. You agree to be subject to the legal jurisdiction of the State of Queensland, Australia.
6. You will not use or attempt to use the Software to do anything that infringes or violates someone else's rights or otherwise violates the law.

9. Termination

1. This agreement remains in force until your rights under this license are terminated by You or us. We may terminate Your license at any time if You fail to comply with any term(s) of this license.
2. Upon termination of the license, You must cease to use the Software and the Data and destroy all Your copies of the Software and the Data.
3. Upon termination of this agreement, the license in Clause 1 will immediately end but otherwise the legal rights, obligations and liabilities that You have to us remain unaffected.

10. Definitions

1. "Hema Maps", "we" or "us" means Hema Maps Pty Ltd ACN 010 601 911, whose principal place of business is First Floor, 21 Brandl St, Eight Mile Plains, Queensland, Australia, 4113 and the licensor of the Product for the purpose of this agreement.
2. "You" or "Your" means the individual or organisation purchasing the Product, and the licensee for the purpose of this agreement.
3. "the Software" means the Hema Software and all the Software and Data supplied or contained therein, or anything provided ancillary thereto, including cloud based storage. For the purpose of this licence agreement, "the Software" includes the product supplied to You, the Data, updates (if any), or any part thereof.
4. "Data" means the information and materials embodied in machine-readable media on the Software including, but not limited to, maps, location data, artwork, illustrations, photographs, images and text.
5. "Hema Cloud" means any cloud based service offered by Hema Maps Pty Ltd in connection with the Software.

HEMA CLOUD TERMS & CONDITIONS OF USE

The following are the Terms and Conditions of Use of the Hema Cloud and associated Software (the "Service"). Before using the Service, please read these Terms and Conditions carefully as well as all rules and policies related to the Service (including usage restrictions and other conditions or procedures that we post or update on or through the Service or on our website www.hemamaps.com.au), the Hema Maps Privacy Policy and Hema Software ("the Software") Terms and Conditions of Use. If You use the Service, You will be bound by these Terms & Conditions of Use. **READ AND OBEY THE IMPORTANT SAFETY RULES AT THE END OF THESE CONDITIONS. ACCESS TO THE HEMA CLOUD REQUIRES YOU TO HAVE INTERNET ACCESS. INTERNET SERVICES MAY NOT BE AVAILABLE AT YOUR PRESENT OR INTENDED LOCATION OR MAY BE VERY EXPENSIVE.**

1. The Service

1. The Service provides features and functionality that allow You to store, retrieve, manage and use Your stored trips, tracks, POI data and photos within the Software. By using the Service, You are promising us to store, manage and use Your data on Your behalf within the Software or Service.
2. The Service may offer free and paid plans, which have different storage

capacity limits.

3. The storage limit for any free Service Plan may be amended or withdrawn by us at any time.

4. Where Your use of the Service has or will exceed the free data storage allowance, You may purchase additional Service Plans for a fee, and subject to the terms and conditions, as published from time to time on our website www.hemamaps.com.au.

2. Usage Rules

1. Subject to the usage rules and restrictions in this agreement, we grant You a non-exclusive, non-transferable right to use the Service for Your personal, non-commercial, recreational use. We do not grant You the right to use the Service for the purposes of redistributing or otherwise using any of our content for Your own business purposes unless You are expressly licensed to do so by us in writing.

2. You may use the Service only for personal, non-commercial use. You may not use the Service to store, transfer or distribute content of or on behalf of third parties, to operate Your own content application or service, to resell any part of the Service or for any form of unlawful file sharing.

3. You are solely responsible for Your data stored within the Service, including for ensuring that it has been lawfully acquired, for complying with all applicable copyright and other laws and licenses, and for maintaining a back-up of it.

4. You will be required to choose a user name and/or a password when registering with the Service. You are responsible for keeping Your login credentials secret. You accept that You will be personally liable for all activities conducted and transactions concluded using Your login credentials.

5. You may need to register the devices You use with the Service, and we may limit the number of devices You can register and the number of devices from which You can use the Service at any one time. There may be limits on the types of content You can store using the Service, such as file types we don't support. If You exceed Your Service Plan's storage limit, including by downgrading or not renewing Your Service Plan, You may no longer be able to access Your data. We may impose other restrictions on Your use of the Service.

6. We may use, access and retain Your data in order to provide the Service to You and enforce the terms of the Agreement, and You expressly give us all permissions we need to do so. These permissions include, for example, the rights to copy Your data for backup purposes and access to Your data to provide technical support. However, we do not guarantee You access to Your data and You are responsible for maintaining Your own backup. Hema Maps respects Your privacy and Your data is subject to the Hema Maps Privacy Policy, located at www.hemamaps.com.au/en/Policies/Privacy.

7. We do not monitor, edit, control or filter the content submitted to this Service by our users. Such content does not represent our views and we have not authorized or endorsed such content. Where it contains location data or information, it may be inaccurate.

8. Notwithstanding that the Service may furnish You with links to third party websites or services and that some third party websites or

services may contain links to this Service we do not control, endorse or approve the activities or content of any such third party websites or services. Please contact the relevant web site or service provider if You have a complaint about the activities or contents of a third party website or service.

9. You may not use Your access to this Service in a manner that would bring us, our business and/or any of our personnel into Disrepute. Furthermore, You may not access this Service for unlawful purposes or use it in a manner which infringes our rights or the rights of any other person or restricts or inhibits the use of or enjoyment of this Service by any other person. In this regard, You must comply with the laws, regulations and codes of conduct applicable to Your use of this Service. You may not post or transfer any material to our Service that is unlawful or violates any third party's rights or which is obscene, incites harmful behaviour, misleading, inaccurate, defamatory, illegal, in breach of any copyright or other intellectual property right, constitutes unsolicited commercial communications, or is damaging to data, Software or the performance of our Service. We may remove any content You have submitted to this Service and/or suspend Your access to any part of this Service at any time without notice.

3. Services Provided by Hema Maps

1. The Service may utilise data and related content on Your device and collect other information that may be used to identify Your data and related content including metadata from Your device. The Service may provide Hema Maps with information relating to Your use and the performance of the Service, as well as information regarding the devices on which You download and use the Service. For example, this information may include the device type, mobile network connectivity, IP address of the device, information about Your internet service provider, information about when the Software is launched, individual session lengths for use of the Service, information about the content used through the Service, or occurrences of technical errors. Any information we receive is subject to the Hema Maps Privacy Policy, located at www.hemamaps.com.au/en/Policies/Privacy.
2. Hema Maps reserves the right to outsource the provision of services to third-parties where it is necessary including the provision of Cloud Services.
3. You agree that the form and nature of the Service may change from time to time without prior notice being given to You.
4. Hema Maps reserves the right to change, suspend, remove or disable access to any of the Services at any time without written notice.

4. Usage restrictions

1. You may not, and You will not encourage, assist or authorize any other person to (a) modify, reverse engineer, decompile or disassemble, or otherwise tamper with, the Service or (b) circumvent, disable or duplicate any methodology we use to identify and use data from Your account and include it within our service or database.
2. Without limiting clause 4 sub-clause 1 above, this Service does not permit You, and You agree that You will not (except where we give our express written consent or You are expressly permitted by law):

- a. commercialise, or attempt to commercialise, or derive any monetary reward or commercial benefit (whether a fee is charged for it or not) from the use or sale of the Service, the Data or user data (including any Data You or other users have created or stored in the Software or Hema Cloud) or any part of it (including but not limited to any location data or other geographical information contained in, or copied or obtained from, the Software whether modified or not). This includes but is not limited to supplying part or all of the content into an open source or not for profit database e.g crowd-sourcing, open street map;
 - b. use the Service on any device other than a device that is owned or controlled by You. You will not distribute or make the Service available over a network where it could be used by multiple devices at the same time;
 - c. digitise or edit the Service or take a digital or analogue image, photograph or screenshot of the Service, other than for the purpose of seeking technical support from us;
 - d. remove, obscure or interfere with any copyright notice, trademark, warning or disclaimer contained in the Service;
 - e. use all or any part of the Data to make a map, guide, publication, website, navigational aid or publication for the purpose of supply to others for commercial benefit or promotion, whether a fee is charged for it or not;
 - f. transfer, give, assign, rent, lease, sell, charge, exchange, adapt, decompile, disassemble, create a derivative product or otherwise deal with the Software other than in the normal course of use, and subject to this to these Terms & Conditions, as amended from time to time;
 - g. reproduce in any way, copy or extract the Service or the Data, in whole or in part and give, sell, rent, market or distribute it to anyone else, whether a fee is charged for it or not;
 - h. copy the Service or any data stored in the Hema Cloud onto another storage device other than as expressly permitted by clause 4 sub-clause 2;
 - i. without limiting any of the paragraphs (e) to (h) above, copy, or attempt to copy, the location data, maps points/places of interest (POI's), names, places, symbols, road markings, layout or other geographical information contained in the Software or Service, or use such information or data as a reference to make any other product, or otherwise extract, reverse engineer, decompile, modify, disassemble, attempt to derive the source code of, modify, or create or attempt to create a new or derivative works of or from the Software or Service;
 - j. use the Service in a manner contrary to any agreement You have with any third party;
 - k. Sub license or assign Your rights under this license to anyone.
3. You acknowledge that the Service and any related content (if applicable) and any Data or content we provide to You contain valuable intellectual property. You also acknowledge that some content may be provided under licence from third party providers and this content is subject to the same intellectual property laws. We or our suppliers may impose further restrictions on Your use of the Service, the Software (if applicable) or the Data at any time, as we or they may deem to be

reasonably necessary to protect our respective intellectual property rights, by the giving of notice to You.

4. The Service, the Data and the Software is protected by copyright law and international treaties. Unauthorised reproduction or distribution of this Software, or any portion of it, may result in severe criminal and civil penalties and will be prosecuted to the maximum extent possible under law.

5. Ownership:

Subject to this clause 5:

1. Hema Maps expressly reserves all copyright and any other intellectual property rights to the Software, the Data, including (without limitation) places of interest (POIs), and any or all maps created or published by Hema Maps and the Hema Cloud and only grants You a limited licence to use the Software and the Data in the manner permitted by these Terms & Conditions.

2. HERE North America LLC is the publisher of the base data used under licence for the Street, Terrain and Satellite Maps and is the owner of the intellectual property rights within, which are used in the product under licence.

3. Contains information licenced from Open Street Maps, Geoscience Australia, Camps Australia Wide, Landgate (Western Australian Land Information Authority) and other State Government bodies.

4. Hema Maps may add other licenced software from time to time.

5. Other than as specified herein, and without limiting clause 5 sub clause 1, You agree that Hema Maps owns the intellectual property rights to the Data, whether in its original form or as modified, printed and/or copied by You.

6. Subject to clause 5 sub clause 1 and clause 5 sub clause 2 above, You own the content (excluding the Data in its original or modified form) that You create using the Service (e.g. Your photographs). However, You grant us a non-exclusive, perpetual, transferable, sub-licensable, royalty-free, worldwide license to use any IP content that You input or generate by using the Service, including (but not limited to) reviews, comments, photos, places of interest, tracks, waypoints, or other personal information or by-products of the Service.

6. Limited warranties

Save to the extent prohibited by law:

1. while the Service has been produced and supplied in good faith, Hema Maps makes no warranty or representation about the availability, accuracy, completeness, reliability or currency of the Service;

2. the Service is provided "as is" and "as available", with all faults and without warranty of any kind. Hema Maps disclaims all other warranties, either express or implied, including warranties of merchantability, fitness for purpose or for a particular purpose and non-infringement of third party rights unless such warranties cannot be excluded by law.

Hema Maps does not warrant against interference with Your enjoyment of the Service, that the Service will meet Your requirements or that the operations of the Service itself or in conjunction with other products will be uninterrupted or error free.

3. You expressly acknowledge and agree that use of the Service is at Your sole risk and that the entire risk as to suitability, satisfactory quality,

reliability, performance, accuracy and effort is with You;

4. although Hema Maps or a third party may provide technical support, Hema Maps does not warrant that technical support will be provided for the Service;

5. no oral or written information or advice given by Hema Maps, agents or employees shall create or extend existing warrants. You must not rely on any such information or advice unless in writing and signed by an authorised representative of Hema Maps.

7. Limitation of liability

1. The Service displays, includes or makes available content, data, information, applications collected by or supplied by third parties, which may contain errors, omissions, inaccuracies or faults. By using the Service, You acknowledge and agree that Hema Maps is not responsible for examining or evaluating the content, quality, currency, accuracy, completeness, legality, or any other aspect of such third party data.

2. You use and rely on the Service entirely at Your own risk and should not solely rely on the results or information obtained from the Service for any purpose, including navigation.

3. To the extent not prohibited by law, the liability of Hema Maps for any breach of an express, statutory or implied warranty shall be limited, at its option, to the cost of replacement of the Service or a refund of the price paid by You.

4. To the extent not prohibited by law, Hema Maps shall not be liable for any loss or damage to person or property, or any incidental, special, indirect or consequential damages whatsoever, including without limitation, loss of income, loss of revenue, trade, business, information or profits or any other loss arising from the installation or use of the Service or reliance upon any Data (irrespective of whether or not the Data is used in any navigation system or for the purposes of navigation) whether based on breach of contract, tort (including negligence), product liability or otherwise.

5. The Service may enable access to maps, content, services and websites provided by us or third parties. If these are provided, they are done so solely as a convenience to You and may be withdrawn at any time.

Access to these services may require internet access, which You will need to arrange and pay for. Internet services may not be available at Your location or may be very expensive. Because of the nature of the internet, it is possible that these sites may contain computer viruses or material which You may find offensive. Hema Maps does not warrant or endorse, and disclaims liability to You or any other person, for any third party maps, content, services, and web sites.

6. Hema Maps shall not be liable for any information, advice or technical support given by a third party unless in writing and signed by an authorised representative of Hema Maps.

8. Collection of information and privacy policy

1. You agree that we may collect and use technical data and related information, including information about Your device, system or application Software to facilitate the provision of the Software or Service support, Software updates and other services (if any) in connection with the Service or Software. We may use this information,

so long as it is in a form that does not personally identify You, to improve our products or services and so long as our use in accordance with our Privacy policy as updated from time to time, www.hemamaps.com.au/en/Policies/Privacy.

2. By submitting any ideas, reviews, comments, corrections, feedback and/or proposals ("Feedback") to Hema through the Service or Software or other means, You acknowledge and agree that the Feedback is Your own work, and we may freely use, distribute, exploit and further develop, modify or use it as we see fit without any obligation to compensate You (just as You have no obligation to offer Feedback), and that Hema may already have similar development ideas to the Feedback.

9. General

1. This Agreement shall be governed by and interpreted in accordance with the laws of the State of Queensland, Australia. You agree to be subject to the legal jurisdiction of the State of Queensland, Australia.

2. This agreement incorporates the terms of the HERE End User Licence Agreement, the Map box End User Licence Agreement and, where applicable, the Terms and Conditions governing the use of the Hema Software. It otherwise makes up the entire agreement between the parties regarding the Service, and supersedes any prior agreements.

3. If any portion of this agreement, or the incorporated agreement(s), is found to be unenforceable, the remaining portion will remain in full force and effect.

4. If Hema Maps fails to enforce any terms of this agreement, this will not constitute a waiver.

5. You will not use or attempt to use the Service or Software to do anything that infringes or violates someone else's rights or otherwise violates the law.

10. Changes, Suspension and Termination

1. We may change, suspend or discontinue the Service or any part of it at any time without notice. If we discontinue the Service, we will give You a prorated refund of any fees (if any) paid for Your Service Plan based on the number of full months remaining in Your Service Plan. There may be unusual circumstances where due to legal reasons we may no longer be able to store or provide You with access to particular content.

2. Your rights under the Agreement will automatically terminate without notice if You fail to comply with its terms. We may terminate the Agreement or restrict, suspend or terminate Your use of the Service at our discretion without notice at any time, including if we determine that Your use violates the Agreement, is improper, substantially exceeds or differs from normal use by other users, or otherwise involves fraud or misuse of the Service or harms our interests or those of another user of the Service. If Your Service Plan is restricted, suspended or terminated, You may be unable to access Your data and You will not receive any refund of fees or any other compensation.

3. Upon termination of this agreement, Your licence to use the Service will immediately end but otherwise the legal rights, obligations and liabilities that You have to us remain unaffected.

11. Definitions

1. "Hema Maps", "we" or "us" means Hema Maps Pty Ltd ACN 010 601 911, whose principal place of business is First Floor, 21 Brandl St, Eight Mile Plains, Queensland, Australia, 4113 and the licensor of the Product for the purpose of this agreement.
2. "You " or "Your" means the individual or organisation purchasing the Product, and the licensee for the purpose of this agreement.
3. "the Software" means the Hema Software and all or any part of the Data and related items supplied or contained therein or ancillary thereto, as updated from time to time.
4. "Service" means the Hema Cloud and all the Software, data and related items stored or contained therein.
5. "Data" means the information and materials embodied in machine-readable media on the Hema Cloud or, if applicable, the Software, and supplied to You, including, but not limited to, maps, location data, artwork, illustrations, photographs, images and text.

12. Safety First

1. Always be prepared, drive carefully and travel responsibly.
2. The Hema Cloud may give You access to location data and road conditions compiled by us or provided by Yourself or others, which has not been checked.
3. Road conditions are constantly changing, and the Service may contain errors, omissions or inaccuracies. Location data or navigational information is provided as a general guide only and is not intended to be relied upon as a sole means of navigation or in situations where precise location information is needed, or where erroneous, inaccurate or incomplete data may lead to death, personal injury, property or environmental damage. You must make Your own enquiries in relation to conditions and the availability of fuel, drinking water, supplies and services.
4. Depiction of a road or track is not an assurance of safety or manner of passage or public right of way and information contained therein does not replace traffic signs, lights, road markings, speed limits and other road rules.
5. You must take care of Your own personal safety, and (if applicable) obey the road rules at all times. Do not operate the Service while driving. Do not use or operate any mode of transport or attempt any journey while under the influence of alcohol or other substances.
6. You acknowledge that the Service is for planning purposes only and You should make Your own enquiries and exercise Your own judgment in related to weather conditions, construction, road closures or other events that may impact the journey You are undertaking.
7. Hema would always suggest that a paper-based map be taken on any trip rather than sole reliance on a GPS unit or mobile device for navigation. In addition, a fully tested GPS tracking device and satellite phone is also recommended for outback travel in Australia.

Privacy Policy

Hema Maps is committed to protecting your privacy and developing technology that gives you the most powerful and safe online experience. This Statement of Privacy applies to the Hema Maps Website, Digital Apps,

Devices and Cloud based Services (collectively “Services”) and governs data collection and usage. By using any of these Services, you consent to the data practices described in this statement.

13. Collection of your Personal Information

Hema Maps collects personally identifiable information, such as your e-mail address, name, home or work address or telephone number. Hema Maps also collects anonymous demographic information, which is not unique to you, such as your Postcode, age, gender, preferences, interests and favorites. There is also information about your computer hardware, digital devices and Software that is automatically collected by Hema Maps. This information can include: your device type, mobile network connectivity, IP address, browser type, domain names, access times and referring Website addresses. This information is used by Hema Maps for the operation of the Services, to maintain quality of the service, and to provide general statistics regarding use of the Hema Maps Services.

Please keep in mind that if you directly disclose personally identifiable information or personally sensitive data through Hema Maps public message boards, this information may be collected and used by others. Note: Hema Maps does not read any of your private online communications.

Hema Maps encourages you to review the privacy statements of Websites or third party service providers you choose to link to from the Hema Maps Services so that you can understand how those Websites collect, use and share your information. Hema Maps is not responsible for the privacy statements or other content on Websites outside of the Hema Maps and Hema Maps family of Websites or Services.

14. Use of your Personal Information

Hema Maps collects and uses your personal information to operate the Services you have requested and to improve our products or Services. Hema Maps also uses your personally identifiable information to inform you of other products or services available from Hema Maps and its affiliates. Hema Maps may also contact you via surveys to conduct research about your opinion of current services or of potential new services that may be offered. Hema Maps does not sell, rent or lease its customer lists to third parties. Hema Maps may, from time to time, contact you on behalf of external business partners about a particular offering that may be of interest to you. In those cases, your unique personally identifiable information (e-mail, name, address, telephone number) is not transferred to the third party. In addition, Hema Maps may share data with trusted partners to help us perform statistical analysis, send you email or postal mail, provide customer support, or arrange for deliveries. All such third parties are prohibited from using your personal information except to provide these services to Hema Maps, and they are required to maintain the confidentiality of your information. Hema Maps does not use or disclose sensitive personal information, such as race, religion, or political affiliations.

Hema Maps keeps track of the Services our customers visit within Hema Maps Service offering, in order to determine which Hema Maps services are the most popular. This data is used to deliver customized content and other services within Hema Maps to customers whose behaviour indicates that they are interested in a particular subject area.

Hema Maps Services will disclose your personal information, without notice,

only if required to do so by law or in the good faith belief that such action is necessary to: (a) conform to the edicts of the law or comply with legal process served on Hema Maps or the site; (b) protect and defend the rights or property of Hema Maps; and, (c) act under exigent circumstances to protect the personal safety of users of Hema Maps, or the public.

15. Use of Cookies

The Hema Maps Services use “cookies” to help you personalize your online experience. A cookie is a text file that is placed on your hard disk by a Web page server. Cookies cannot be used to run programs or deliver viruses to your computer. Cookies are uniquely assigned to you, and can only be read by a web server in the domain that issued the cookie to you.

One of the primary purposes of cookies is to provide a convenience feature to save you time. The purpose of a cookie is to tell the Web server that you have returned to a specific page. For example, if you personalize Hema Maps pages, or register with Hema Maps site or services, a cookie helps Hema Maps to recall your specific information on subsequent visits. This simplifies the process of recording your personal information, such as billing addresses, shipping addresses, and so on. When you return to the same Hema Maps Service, the information you previously provided can be retrieved, so you can easily use the Hema Maps features that you customized.

You have the ability to accept or decline cookies. Most Web browsers automatically accept cookies, but you can usually modify your browser settings to decline cookies if you prefer. If you choose to decline cookies, you may not be able to fully experience the interactive features of the Hema Maps services or Websites you visit.

16. Security of your Personal Information

Hema Maps secures your personal information from unauthorized access, use or disclosure. Hema Maps secures the personally identifiable information you provide on computer servers in a controlled, secure environment, protected from unauthorized access, use or disclosure. When personal information (such as a credit card number) is transmitted to other Websites, it is protected through the use of encryption, such as the Secure Socket Layer (SSL) protocol.

17. Changes to this Statement

Hema Maps will occasionally update this Statement of Privacy to reflect company and customer feedback. Hema Maps encourages you to periodically review this Statement to be informed of how Hema Maps is protecting your information.

18. Contact Information

Hema Maps welcomes your comments regarding this Statement of Privacy. If you believe that Hema Maps has not adhered to this Statement, please contact Hema Maps at info@Hemamaps.com.au. We will use commercially reasonable efforts to promptly determine and remedy the problem.

END USER LICENCE AGREEMENT FOR DATA PRODUCTS DISTRIBUTED BY HERE

THIS IS A LICENSE AGREEMENT - AND NOT AN AGREEMENT FOR SALE - FOR YOUR COPY OF HERE MAP DATA AND/OR RELATED CONTENT, INCLUDING ANY ASSOCIATED MEDIA AND EXPLANATORY DOCUMENTATION PROVIDED TO YOU IN CONNECTION WITH THE DATA (COLLECTIVELY, THE "DATA"). BY INSTALLING, COPYING OR OTHERWISE USING THE DATA, YOU ACCEPT AND AGREE TO BE BOUND BY ALL TERMS AND CONDITIONS OF THIS END USER LICENSE AGREEMENT ("AGREEMENT"). IF YOU DO NOT AGREE TO THE TERMS OF THIS AGREEMENT, YOU MUST PROMPTLY RETURN THE DATA, ALONG WITH ALL OTHER ACCOMPANYING ITEMS, TO HERE OR YOUR SUPPLIER TO BE ELIGIBLE FOR A REFUND, WHICH SHALL BE SUBJECT TO THE REQUIREMENTS FOR ELIGIBLE RETURNS OF HERE OR YOUR SUPPLIER. TO CONTACT HERE, PLEASE VISIT www.here.com.

If your license to the Data was purchased directly from HERE, then the terms of this Agreement shall be between you and HERE, which shall mean (a) HERE North America, LLC if you are located in the Americas or Asia Pacific regions or (b) HERE Europe B.V. if you are located in any other territory. Please refer to your purchase confirmation for further details about the HERE entities. If your license to the Data was obtained from any other supplier, then the terms provided to you in connection with such purchase shall apply, provided that such terms are no less restrictive and protective of the Data than the terms set forth herein. If you did not receive notice of any terms applicable to the Data when obtained from another supplier, then the terms set forth in this Agreement shall be deemed to apply between you and your supplier.

Ownership

The Data and all copyrights and intellectual property or neighboring rights therein are owned by HERE and its licensors. Ownership of any media on which the Data is contained is retained by HERE or your supplier until you have paid in full any amounts due to HERE or your supplier pursuant to this Agreement or any similar agreement under which the Data is provided to you.

License Grant

Your license to use the Data is non-exclusive and expressly limited to your personal use, or if you are acting on behalf of a business entity, use in your business' internal operations. This license is subject to compliance with the restrictions and limitations set forth herein and does not include the right to grant sublicenses.

Limitations on Use

The Data is restricted for use in the specific system for which it was created. Except to the extent explicitly permitted by mandatory laws, you may not extract or reutilize substantial parts of the contents of the Data, nor reproduce, copy, modify, adapt, translate, disassemble, decompile or reverse engineer any portion of the Data. The Data may not be used for service bureau, timesharing or other similar purposes. If you reside in countries that are subject to the European Software Directive and wish to obtain interoperability information as meant in (the national laws based on) such Directive, you shall notify HERE and provide HERE with reasonable

opportunity to provide said information on reasonable terms, including costs, to be determined by HERE.

The Data includes certain information and related content provided under license from third parties and is subject to the applicable supplier terms and copyright notices set forth at the following URL:
</terms/general-content-supplier/terms-and-notice>.

Transfer of License

You may not transfer or resell the Data to third parties, except when installed in the system for which it was created or when you do not retain any copy of the Data, and provided that the recipient agrees to all terms and conditions of this Agreement and confirms this in writing to HERE. Multi-disc sets may only be transferred or sold as a complete set as provided to you and not as a subset thereof.

Warnings

The Data may contain inaccurate or incomplete information due to the passage of time, changing circumstances, sources used and the nature of collecting comprehensive geographic data, any of which may lead to incorrect results. The Data does not include or reflect information on - inter alia - travel time and may not include neighborhood safety; law enforcement; emergency assistance; construction work; road or lane closures; road slope or grade; bridge height, weight or other limits; road conditions; or special events depending on the navigation system brand that you possess.

No Warranty

THE DATA IS PROVIDED TO YOU "AS IS", AND YOU AGREE TO USE IT AT YOUR OWN RISK. HERE AND/OR YOUR SUPPLIER (AND THEIR RESPECTIVE LICENSORS AND SUPPLIERS) MAKE NO GUARANTEES, REPRESENTATIONS OR WARRANTIES OF ANY KIND, EXPRESS OR IMPLIED, ARISING BY LAW OR OTHERWISE, INCLUDING BUT NOT LIMITED TO, CONTENT, QUALITY, ACCURACY, COMPLETENESS, EFFECTIVENESS, RELIABILITY, FITNESS FOR A PARTICULAR PURPOSE, USEFULNESS, USE OR RESULTS TO BE OBTAINED FROM THE DATA, OR THAT THE DATA OR USE THEREOF WILL BE UNINTERRUPTED OR ERROR FREE.

Disclaimer of Warranty

TO THE EXTENT PERMITTED BY LOCAL LAW, HERE AND/OR YOUR SUPPLIER (INCLUDING THEIR RESPECTIVE LICENSORS AND SUPPLIERS) DISCLAIM ANY WARRANTIES, EXPRESS OR IMPLIED, OF QUALITY, PERFORMANCE, MERCHANTABILITY, FITNESS FOR A PARTICULAR PURPOSE OR NON-INFRINGEMENT.

Limitations of Liability

TO THE EXTENT PERMITTED BY LOCAL LAW, HERE AND/OR YOUR SUPPLIER (INCLUDING THEIR RESPECTIVE LICENSORS AND SUPPLIERS) SHALL NOT BE LIABLE TO YOU IN RESPECT OF ANY CLAIM, DEMAND OR ACTION, IRRESPECTIVE OF THE NATURE OF THE CAUSE OF THE CLAIM, DEMAND OR ACTION ALLEGING ANY LOSS, INJURY OR DAMAGES, DIRECT OR INDIRECT, WHICH MAY RESULT FROM USE OR POSSESSION OF THE DATA; OR FOR ANY LOSS OF PROFIT, REVENUE,

DATA, CONTRACTS OR SAVINGS, OR ANY OTHER DIRECT, INDIRECT, INCIDENTAL, SPECIAL OR CONSEQUENTIAL DAMAGES ARISING OUT OF YOUR USE OF OR INABILITY TO USE THE DATA, ANY DEFECT IN THE DATA, OR THE BREACH OF THESE TERMS OR CONDITIONS, WHETHER IN AN ACTION IN CONTRACT OR TORT OR BASED ON A WARRANTY, EVEN IF HERE AND/OR YOUR SUPPLIER OR THEIR RESPECTIVE LICENSORS HAVE BEEN ADVISED OF THE POSSIBILITY OF SUCH DAMAGES.

This Agreement is not intended to and does not (a) change or exclude any statutory consumer rights that cannot be lawfully changed or excluded, or (b) limit or exclude any right that you may have against any other party if you did not purchase the Data directly from HERE. Some jurisdictions do not allow certain liability exclusions, damage limitations, or disclaimers of warranty. In no event shall HERE or your supplier be liable for damages in excess of the price that you paid for your copy of the Data.

Returns

For returns of Data purchased from HERE and delivered electronically, please refer to the 'Cancellations and Refunds' provisions in the HERE Service Terms. For returns of Data purchased from HERE and delivered on physical media, please refer to the applicable terms made available at the time of purchase. In the event that you wish to return Data purchased from another supplier, please refer to the applicable terms of purchase of your supplier for details.

Compliance With Laws

You agree to use the Data in compliance with all applicable laws, rules and regulations, including local laws, rules and regulations of the country or region in which you reside or in which you obtain or use the Data. You agree not to export from anywhere any part of the Data or any direct product thereof, except in compliance with, and with all licenses and approvals required under, applicable export laws, rules and regulations, including but not limited to the laws, rules and regulations administered by the Office of Foreign Assets Control of the U.S. Department of Commerce and the Bureau of Industry and Security of the U.S. Department of Commerce. To the extent that any such export laws, rules or regulations prohibit HERE or your supplier from complying with any of its obligations to deliver or distribute the Data, such failure shall be excused and shall not constitute a breach of this Agreement.

Governing Law

This Agreement shall be governed by the laws of the State of Illinois (for Data for the Americas and/or the Asia Pacific region) or The Netherlands (for Data for Europe, the Middle East and Africa), without giving effect to conflict of laws provisions, or the United Nations Convention for Contracts for the International Sale of Goods, which is explicitly excluded. For any and all disputes, claims and actions arising from or in connection with the Data, you agree to submit to the personal jurisdiction of (a) the State of Illinois for claims related to Data for the Americas and/or the Asia Pacific region, and (b) The Netherlands for Data for Europe, the Middle East and/or Africa.

Entire Agreement

The terms and conditions contained in this Agreement, including any additional terms provided in connection with a purchase from any other supplier, constitute the entire agreement between HERE or your supplier

(whichever is applicable) and you pertaining to the subject matter hereof, and supersedes in their entirety any and all written or oral agreements previously existing between HERE or your supplier and you with respect to such subject matter.

If any portion of this Agreement is found illegal or unenforceable, that portion shall be severed and the remainder of this Agreement shall be given full force and effect.

U.S. Government End Users

If the Data is being acquired by or on behalf of the United States Government or any other entity seeking or applying rights similar to those customarily claimed by the United States Government, the Data is a “commercial item” as that term is defined at 48 C.F.R. (“FAR”) 2.101, is licensed in accordance with this Agreement, and each copy of Data delivered or otherwise furnished shall be marked and embedded as appropriate with the following “Notice of Use”, and be treated in accordance with such Notice:

NOTICE OF USE

CONTRACTOR (MANUFACTURER/ SUPPLIER) NAME:

HERE CONTRACTOR (MANUFACTURER/SUPPLIER) ADDRESS:

425 West Randolph Street, Chicago, IL 60606

The Data is a commercial item as defined in FAR 2.101 and is subject to the terms set forth in this Agreement. If the Contracting Officer, federal government agency, or any federal official refuses to use the legend provided herein, the Contracting Officer, federal government agency, or any federal official must notify HERE prior to seeking additional or alternative rights in the Data.

© 1987-2016 HERE. All rights reserved.

Where to get more help

Hema Technical Support information can be found at:
www.hemamaps.com/support

This site contains video tutorials, product information and frequently asked questions. It also allows you to submit a technical support ticket so that our team can follow up on your query.

How to contact us

Hema Maps Pty Ltd
Level 1, 21 Brandl St,
Eight Mile Plains QLD 4113
T: +61 7 3340 0000
E: info@hemamaps.com.au



Hema Navigator® is a trademark of Hema Maps Pty Ltd. registered in Australia and other countries and may not be used without the express permission of Hema Maps Pty Ltd.

Prepared to explore.