



Batteries that last and last



Model: CC1212-XLi

OWNER'S MANUAL

AUSTRALIAN & NEW ZEALAND STANDARD AS/NZS 60335.2.29 APPROVED

Congratulations on purchasing your Century 12-volt automatic battery charger, maintainer and rejuvenator. Please take time to carefully read and understand this manual before using this charger.

IMPORTANT SAFETY ADVICE AND WARNINGS

- The CC1212-XLi is designed to charge and maintain **12V conventional lead-acid batteries and compatible Lithium (LFP) batteries**, including:

Battery Type	Battery Type Setting to Select
Sealed Maintenance Free Calcium Batteries	Calcium SMF
Maintainable Flooded Batteries	AGM/FLOODED/EFB
AGM & EFB Batteries	AGM/FLOODED/EFB
GEL Batteries	GEL
Lithium LiFePO4 Batteries	Lithium (LFP)

- Always refer to the battery manufacturers specifications and recommendations if you're unsure of your battery charging requirements.
- Explosive gases may escape from the battery during charging so please ensure the battery is charged in a well-ventilated area - never in a closed room.
- NEVER smoke, use an open flame or create sparks near a battery or charger during charging operation as explosive gases may cause an explosion. Flames, sparks, burning cigarettes or other ignition sources must be kept away at all times.
- Battery acid can cause burns. Suitable hand, eye and face protection and protective clothing must be worn.
- First Aid: For advice, contact the Poisons Information Centre in Australia (phone 13 11 26) or the National Poisons Centre in New Zealand (phone 0800 764 766), or contact a doctor immediately. If battery acid enters your eyes, hold eyelids apart and flush the eye continuously with running water. Continue flushing for at least 15 minutes or until advised to stop by poisons information centre, national poisons centre or doctor. If battery acid contacts your skin or clothing, wash immediately with soap and water. If hair contact occurs, remove contaminated clothing and flush hair with soap and running water. Someone should always be within range of your voice.
- If electrolyte is swallowed, do NOT induce vomiting – give a glass of water. Seek immediate medical assistance.
- When working with lead-acid batteries, remove personal metal items such as rings, bracelets, necklaces, watches and make sure you don't short circuit the battery terminals with any type of metal tool, piece of jewellery or other conductors as this will cause an explosion. You can wrap your spanner with insulation tape to minimise the risk of a short circuit.
- Acid spill response: Bund and neutralise spills with soda ash or other suitable alkali. Dispose of residue as chemical waste or as per local requirements.
- This charger is designed for indoor use only and should not be exposed to water, rain, snow, liquids etc.
- Do not attempt to use the charger if it has been dropped or damaged or if the cables or plugs are damaged.
- Never attempt to charge a damaged battery, frozen battery or non-rechargeable battery.
- **If the supply cord is damaged, it must be replaced by the manufacturer, its service agent or similarly qualified persons in order to avoid a hazard.**
- Never place the charger on the battery or battery on the charger.
- Do not disassemble the charger. Take it to a qualified and authorised person for repair.

- If using a generator, you must ensure you use a surge protector to protect the charger from voltage spikes.
- The charger must not be used or played with by infirm persons or children. Also keep away from pets.
- Turn engine and or charger off before disconnecting a battery*
* In some vehicles, ignition may be required to be placed in accessory mode where electronic memory minder is present.

MAIN FEATURES

- **The battery charger is easy to use and requires no technical experience.**
- **It is a selectable automatic smart battery charger & maintainer with reconditioning mode that is fully microprocessor controlled with safety timers at every stage.**
- **9 Stage process for Lead-acid type batteries (GEL, AGM/FLOODED/EFB, CALCIUM SMF)**
 - 1 - Qualification - Battery condition check
 - 2 - Battery rejuvenation (recondition mode)
 - 3 - Soft start charging
 - 4 - Bulk charging
 - 5 - Absorption charging
 - 6 - Equalisation charging
 - 7 - Battery analysis
 - 8 - Float mode
 - 9 - Long term maintenance pulse charge. Recharge Cycle every 21 Days.
- **7 Stage process for Lithium-ion (LiFePO4) type batteries**
 - 1 - Lithium Activation
 - 2 - Soft start charging
 - 3 - Bulk charging
 - 4 - Absorption stage 1
 - 5 - Absorption stage 2
 - 6 - Full
 - 7 - Analysis
- **Battery condition analysis.**
- **Battery voltage retention analysis.**
- **Automatic diagnosis and charge:** On power up, the charger will automatically diagnose the battery condition and determine if the rejuvenation mode (reconditioning) or charge cycle is required.
- **Selectable battery type.**
- **Selectable charge rate / mode.**
 - 12A - Rapid Charge Mode:** Uses maximum charging current (12 Amps) to ensure the fastest charge time. You may hear the fan turn on during this mode.
 - 8A - Silent Charge Mode:** Charges at a reduced charge rate (8 Amps) and the cooling fan is not required.
 - 1A - Maintenance Mode:** Ideal and recommended for long term maintenance charging or for charging smaller batteries. NOTE: When used in maintenance mode, please check that the application's current draw does not exceed the charging current.
- **LFP Wake Up - Power Supply:** 13.8V 12A Max Power Supply Mode which is time limited for 24 Hours before automatically switching back to LITHIUM (LFP) Charging Mode.

- **Patented battery rejuvenation (reconditioning) technology:** The charger has a unique and patented rejuvenation feature which uses high voltage equalising and peak pulse reconditioning to repair sulphated batteries. This feature is fully automatic and depends on the internal impedance of the battery. It also depends on whether the battery is still connected in the vehicle.
- **Ultra-low power consumption (ECO Mode).**
- **Pulse charge for long term maintenance.**
- **Can be left on 24/7 to ensure your battery is always maintained and fully charged:** The battery charger can be left permanently connected all year round. The intelligent charger will monitor the battery voltage and will maintain it at peak performance with a special pulse charge during long term maintenance. Please note that even if the battery charger incorporates this feature **Century Batteries does not recommend leaving the battery charger connected 24/7.**
- **Short circuit and reverse polarity protection.**
- **Heavy-duty and corrosion-resistant output connectors.**
- **Crocodile clips / Ring Terminals:** It comes with a quick connect fly lead and heavy duty, fully insulated crocodile clip harness and ring terminal harness.

TEMPERATURE & SAFETY PROTECTION:











- **INTERNAL OVERHEAT PROTECTION:** The charger has a built-in overheat and overload electronic circuit. This protects the charger from being damaged if overheated or overloaded and will automatically decrease the charging current. Once the unit's internal temperature decreases to a safe level, the charger will resume normal charging.
- **SAFETY TIMER PROTECTION:** The charger has safety timers for every stage. If the battery voltage doesn't reach a certain voltage within a specific time, the unit will stop charging as it is highly likely that you are attempting to charge a severely discharged or heavily sulphated battery. If any of the stage's times out, the charger will immediately stop charging in order to protect the battery. This will be indicated with the fault LED flashing slowly.
- **REVERSE POLARITY:** The charger has reverse polarity protection. If the charger output leads are connected in reverse polarity, the fault LED will come on and the charger will be disabled. Simply unplug the charger from AC power and then connect the output leads to the correct polarity.
- **SHORT CIRCUIT PROTECTION:** The charger will automatically turn off if the output leads are short circuited and the fault LED will come on. This prevents the charger from being damaged if the positive and negative crocodile clips or the ring terminals accidentally touch each other while the charger is turned on.
- **ECO MODE:** This Century battery charger has a built in ultra-low power consumption circuit. If AC power is connected and the battery is disconnected, after 10 seconds the charger will automatically go into ECO mode. During this mode the power drawn is less than 0.36W which totals 0.01kWh per day power consumption. If AC power is connected and the battery is connected, once the battery is fully charged and during the long-term maintenance stage, the total power consumption is around 0.03kWh per day. Both the selected Charge rate and Battery type LEDs will flash GREEN to indicate ECO mode.

BATTERY TYPES & CAPACITY:

- This charger is suitable for 12V conventional lead acid batteries: All SMF [Calcium], AGM/Flooded/EFB, Gel and compatible LITHIUM (LFP) batteries. The Ah (Ampere Hours) capacities shown below are to be used as a general guide only. Some batteries may be able to handle a higher charge current. Refer to the battery manufacturers specifications and recommendations for your charging requirements.

	Model No. CC1212-XLi		
Charge Rate:	1A	8A	12A
Charging	3 - 20Ah	24 - 160Ah	36 - 240Ah
Maintaining	< 100Ah	< 240Ah	< 360Ah

Charge rate advice per vehicle type

	1A	8A	12A
	✓		
	✓		
	✓	✓	
	✓		
	✓		
		✓	✓
		✓	✓
		✓	✓
			✓
			✓

These figures are based on 5 to 30% of battery Ah rating. For optimum charging, 10% of battery Ah rating is recommended for flooded batteries and 20% of battery Ah rating is recommended for AGM & Gel batteries. For LITHIUM (LFP) batteries, check your battery manufacturers specifications.

Visit www.centurybatteries.com.au/battery-charging or www.centurybatteries.co.nz/battery-charging for further advice on which Battery Type and Charge Rate settings to select.

ELECTRICAL PARTS & ACCESSORIES:

AC Power Cord:	1.8m with 3 Pin AU Plug
DC Output Lead:	1.2m with quick connect PP30 Connector
Charging Leads:	Quick connect 60cm Crocodile Clip harness and 60cm Ring Terminal harness

TECHNICAL SPECIFICATIONS:

Model Number	CC1212-XLi
Output	12A @ 12V DC
Input Voltage	220-240V AC/ 1.8A (175W)
Input Frequency	50Hz
Charge Voltage	Gel - 14.1V AGM/Flooded/EFB - 14.4V SMF [Calcium] - 14.7V LITHIUM (LFP) - 14.4V
Equalising Voltage	Gel - 14.3V AGM/Flooded/EFB - 14.6V SMF [Calcium] - 16.2V
Float Voltage	13.6V (Lead-acid type batteries only)
LFP Wake Up - Power Supply	13.8V (24 Hour time limited)
Start Voltage	2V
Operating Temperature	-10 to 40°C
Storage Temperature	-25 to 85°C
Operating Humidity	90% RH Max.
Size (L*W*H)	220mm x 100mm x 55mm
Weight	1.1kg (approx.)
Approvals	AS/NZS, EMC

CHARGING INSTRUCTIONS:

STEP 1 - Pre charge check & electrolyte level check

- Check the battery voltage, type and Ah capacity to ensure the charger is compatible and to determine which Battery Type and Charge Rate settings you will use. Visit <http://www.centurybatteries.com.au/battery-charging> or <http://www.centurybatteries.co.nz/battery-charging> for advice on which Battery Type and Charge Rate settings to select.
- Check the Battery Electrolyte levels. For maintainable batteries, remove the vent caps and if necessary, add distilled water so the levels are halfway between the upper and lower fill lines. On Sealed Maintenance Free (SMF) batteries, check the State of Charge indicator.
- Ensure the battery is in a well-ventilated area and the charger should be as far away from the battery as the cables permit.
- Follow health and safety precautions outlined on page1 of this manual before using the charger.

STEP 2 - Connecting the battery charger to your battery

If the Battery is out of the vehicle:

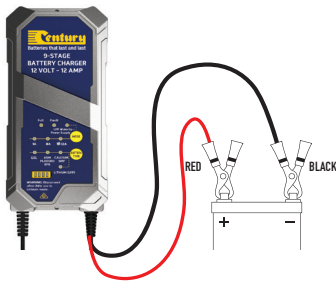

Connect the Red (+) Crocodile clip or ring terminal to the (+) battery terminal. Connect the Black (-) Crocodile clip or ring terminal to the (-) battery terminal.

If the battery is still **in the vehicle**, determine if the vehicle is positively or negatively earthed.

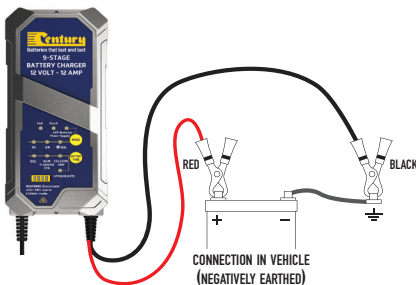

If **Negatively Earthed (Most Common)** – FIRST Connect the Red (+) Crocodile clip or ring terminal lead to the (+) battery terminal and then connect the Black (-) Crocodile clip or ring terminal lead to the vehicle's chassis. **DO NOT** connect the Black (-) lead to the carburettor or fuel lines.

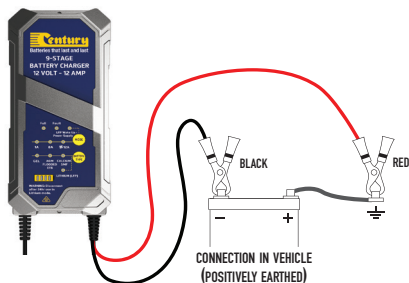

If Positively Earthed – FIRST Connect the Black (-) Crocodile clip or ring terminal lead to the (-) battery terminal and then connect the Red (+) Crocodile clip or ring terminal lead to the vehicle's chassis. DO NOT connect the Red (+) lead to the carburettor or fuel lines.

STEP 3 - Connect the battery charger to Mains Power (240V AC)

- The charger will automatically start when AC power is connected and switched on.
- **IMPORTANT:** Please make sure the correct Battery Type and your desired Charge Rate is selected to suit your battery by pressing the Select Buttons within the first 5 minutes of charging. For Example do not charge a Gel or AGM type Battery on the SMF [Calcium] Battery Type setting as this will damage your battery and / or reduce your battery life.

Note: If the Fault Indicator LED illuminates Red, please check your connections as it is likely that the Positive and Negative Leads are reversed.

THE CHARGING PROCESS: LEAD ACID (Gel, Calcium SMF, AGM/FLOODED/EFB)

1) Qualification - Battery Condition Check

When the charger is first switched on it checks the battery condition to determine whether the battery needs reconditioning. During this qualification process it checks the internal impedance and initial voltage of the battery and it will determine how much charge current, if any that the battery will accept.

2) Automatic Enhanced Battery Rejuvenation

If the initial qualification detected that the battery was in poor condition, the patented rejuvenation process will begin automatically. During the rejuvenation process a high voltage equalising and peak pulse reconditioning charge is used to repair the sulphated battery. This unique patented feature will break down and dissolve the lead-sulphate crystal build up on the battery plates which will extend the life of your battery. It can also balance out high concentrations of acid. The equalisation voltage will be 16V maximum. If the battery voltage doesn't reach 9V within 24 hours, the Rejuvenation process will time out.

3) Soft Start Charging

Gently charges the battery using a reduced charge output until the battery voltages reaches 11V. If the battery voltage doesn't reach 11V within 6 hours, the safety timer protection will stop the unit from charging and the Red Fault LED and 25% LED will start flashing.

4) Bulk Charging - (Charge Voltage depends on battery type selection)

Uses the maximum selected charge output until the battery voltage reaches 14.1/14.4/14.7V. If the battery voltage doesn't reach this within 24 hours, the safety timer protection will stop the unit from charging and the Red Fault LED and 50% or 75% LED will start flashing.

5) Absorption Charging

Uses a constant voltage while reducing the charging output current to ensure the battery receives a full charge without overcharging the battery.

6) Equalisation Charging

A well proven process that carefully overcharges the battery to restore it's full capacity. The Equalisation stage for CALCIUM SMF Battery type selection is automatic. The Equalisation stage for AGM/FLOODED/EFB and GEL Battery Types only occurs if the initial start voltage is below 11 Volts.

7) Battery Analysis

The battery analysis stage checks the condition of the battery after the charge cycle is completed. If the battery voltage drops too quickly during the analysis mode, this means the battery is probably faulty. If the battery analysis failed, this is indicated by the Green Full LED flashing.

8) Float Mode

This stage allows you to keep the charger connected 24/7 to ensure your battery is well maintained and kept 100% fully charged. Float mode will maintain the battery at a constant 13.6V.

9) Long Term Maintenance

During long term maintenance / float mode, the unit will apply a special pulse charge to ensure the battery is kept in optimal condition. Recharge Cycle every 21 days.

THE CHARGING PROCESS: LITHIUM (LFP)

1) Lithium Activation

The charger sends a signal to wake up the Lithium battery management system (BMS) so it can detect the battery voltage and commence charging if safe to do so.

2) Soft Start Charging

Gently charges the battery using a reduced charge output until the battery voltages reaches 10V. If the battery voltage doesn't reach 10V within 6 hours, the safety timer protection will stop the unit from charging.

3) Bulk Charging

Uses the maximum selected charge output until the battery voltage reaches 14V. If the battery voltage doesn't reach 14V within 24 hours, the safety timer protection will stop the unit from charging.

4) Absorption Charging Stage 1

Uses a constant voltage of 14V while reducing the charging output current to ensure the battery receives approximately 90% charge without overcharging the battery.

5) Absorption Charging Stage 2

Steps up the constant voltage to 14.4V while reducing the charging output current to ensure the battery receives a full charge without overcharging the battery.

6) Full

Once the battery is fully charged, the Green Full LED will come on. The charger output will stop. However it will continue to monitor the battery condition as it will enter Long Term Analysis mode.

7) Long Term Analysis

During long term analysis mode, the charger will monitor the battery level and reactivate the charger output if the voltage drops below 12.9V to ensure the battery is always ready when you need it.

Century Batteries does not recommend leaving the battery charger connected for more than 24 hours during LITHIUM (LFP) Mode. Disconnect after 24 hour use.

LFP Wake Up - Power Supply - 13.8V 12A Max (1A, 8A, 12A selectable)

If the Lithium Activation signal isn't waking up your battery BMS you may use this feature to wake it up. With the LITHIUM (LFP) Battery Type selected, press and hold the MODE button for 3 seconds until the LFP Wake Up - Power Supply LED turns ON (Green). The unit will output 13.8V and force the BMS to wake up and the battery will start accepting charge. After a few minutes you can then press and hold the MODE button for 3 seconds to exit LFP Wake Up - Power Supply mode and unit will revert back to charging mode.

This mode is time limited and will automatically switch back to LITHIUM (LFP) charging mode after 24 hours.

STEP 4 - Disconnecting the Battery charger from Battery

- **If the Battery is out of the vehicle:**
 - (1) Switch OFF and Remove the AC Power Socket from the outlet.
 - (2) Remove the Black lead and then the Red lead.
- **If the battery is still in the vehicle:**
 - (1) Switch OFF and Remove the AC Power Socket from the outlet.
 - (2) Remove the lead from the vehicle chassis.
 - (3) Remove the lead from the battery.

Note: Check electrolyte levels if possible after charging as they may need topping up with distilled water. (This does not apply to Sealed Maintenance Free batteries and Lithium type batteries)

LED STATUS INDICATOR / BUTTON FEATURES:

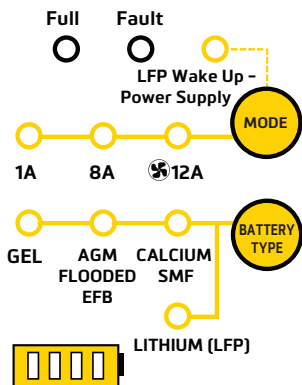

MODE Button:

Press this button (short press) to select your desired charge rate. 1A, 8A or 12A.

Press and hold this button for 3 Seconds to activate / deactivate LFP Wake Up - Power Supply Mode. This mode is only available if LITHIUM (LFP) Battery Type is selected and will revert back to LITHIUM (LFP) charging mode after 24 hours.

BATTERY TYPE Button:

Press this button (short press) to select your battery type. Press and hold this button for 3 Seconds to activate Force

Description					Full	Selected Battery Type	Selected Charge Rate	Fault
	25%	50%	75%	100%				
Eco Mode - energy saving (no battery connected)	OFF	OFF	OFF	OFF	OFF	Flash	Flash	OFF
AC Power on - no battery connected / detected	OFF	OFF	OFF	OFF	OFF	ON	ON	OFF
Auto Rejuvenation mode	Sequential Flash				OFF	ON	ON	OFF
Soft Start Charging	Flash	OFF	OFF	OFF	OFF	ON	ON	OFF
Bulk Charging <13.0V*	ON	Flash	OFF	OFF	OFF	ON	ON	OFF
Bulk Charging >13.0V*	ON	ON	Flash	OFF	OFF	ON	ON	OFF
Absorption Charging	ON	ON	ON	Flash	OFF	ON	ON	OFF
Equalisation Charging	ON	ON	ON	Flash	OFF	ON	ON	OFF
Full Float Maintenance mode	ON	ON	ON	ON	ON	ON	ON	OFF
Auto Rejuvenation - Failed	Sequential Flash				OFF	ON	ON	ON
Soft Start Charge - Time Out	Flash	ON	Flash	OFF	OFF	ON	ON	Flash
Bulk Charge - Time Out <13.0V*	ON	Flash	OFF	OFF	OFF	ON	ON	Flash
Bulk Charge - Time Out >13.0V*	ON	ON	Flash	OFF	OFF	ON	ON	Flash
Reverse Polarity / Short Circuit	OFF	OFF	OFF	OFF	OFF	ON	ON	ON
Sulphation / Shorted cell fail	Flash	Flash	Flash	Flash	OFF	ON	ON	ON
Over Temperature protection	OFF	OFF	OFF	OFF	OFF	ON	ON	Flash

* 13.5V for LITHIUM LFP

Note: The LFP Wake Up - Power Supply Green LED will be on when in LFP Wake Up - Power Supply Mode.

CHARGING CURVE

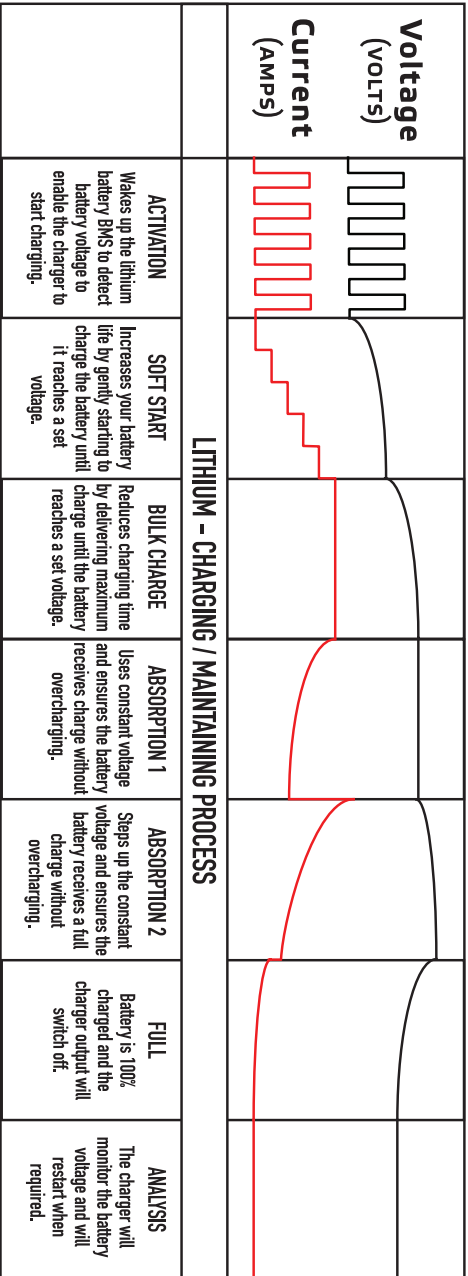
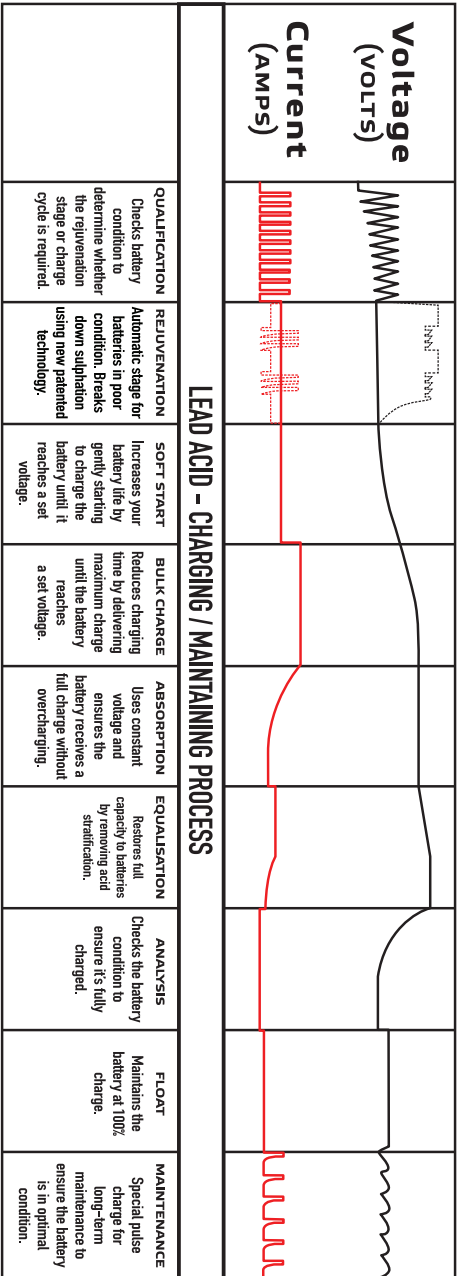

ONLINE RESOURCES

Visit <http://www.centurybatteries.com.au/battery-charging> or <http://www.centurybatteries.co.nz/battery-charging> for more information on battery charging and for advice on which Battery Type and Charge Rate settings to select when using Century's CC1212-XLi battery charger and maintainer.

TROUBLE SHOOTING

Problem	Indication	Possible Causes	Suggested Solution
Charger does not work?	No Indicator lights on	- No AC power	- Check AC connections and make sure the AC Power Point is switched ON. - Try a different AC Power Point which you know is working.
Charger has no DC output?	Fault Red LED is ON	- Output is short circuited - Reverse polarity protection - Loose / bad connection to the battery	- Check DC connection between charger and battery and make sure they are not short circuited. (Touching each other) - Check that the crocodile clips have not fallen off or come loose. - Check that the crocodile clips/ ring terminals are connected to the correct polarity. Note: The charger output is only present when connected to a battery.
No charging current?	Fault Red LED is Flashing	- Battery is severely sulphated - Battery has a damaged cell - Overheat protection mode	- Check the battery condition, age etc. - Battery may need replacement. - Move battery & charger to a cooler environment.

The full / float light won't come on.	Fault Red LED is Flashing or Full Green LED is Flashing	<ul style="list-style-type: none"> - Battery Ah capacity too large for the battery charger and it has time out - Battery is defective - Battery is severely sulphated 	<ul style="list-style-type: none"> - Check the charger specifications match the battery capacity. Eg. make sure battery capacity is not too big for the charger. - Battery may need replacement. - Charge rate selected might be too low for the battery. Switch charger off and on and try again or try a higher charge rate setting providing it doesn't exceed the maximum charge limit for your battery.
---------------------------------------	---	--	---

Note: If the Battery Type and Charge Rate LED's (1A or 8A or 12A) are both flashing, this indicates no battery is detected or is below 2V and the unit is in Eco Power Saving mode.

If your battery voltage is below 2V, try the Force Start Mode by pressing and holding the Battery Type button for 3 seconds until the 4 battery LED's start scrolling. This will force the charger to output for 30 seconds and begin charging.

5 YEAR PRODUCT WARRANTY

Century Yuasa Batteries Pty Ltd (ABN 66 009 685 232) of 37-65 Cobalt Street, Carole Park, QLD, 4300, Australia and Century Yuasa Batteries (NZ) Ltd (NZBN 9429039377319) of 259 Church Street, Onehunga, Auckland, 1643, New Zealand warrant to the Customer that this product is substantially free from defects in materials and workmanship under normal use for a period of Five Years from the Date of Purchase. Please ensure you keep a copy of your purchase receipt on file as this will be required to validate your warranty.

Obtaining Warranty Service:

Within the warranty period, the Customer must contact the authorised supplier / retailer where the product was purchased or alternatively you can contact Century Yuasa Batteries through one of the following methods:

Phone - Australia: 1300 362 287

Phone - New Zealand: 0800 93 93 93

Website: www.centurybatteries.com.au / www.centurybatteries.co.nz

If Century Yuasa Batteries concludes that while under normal use, a product failure or malfunction occurred during the warranty period and was caused by a defect in material or workmanship (see Exclusions), the Customer will be asked to return the product to the original point of purchase. The product must be packaged appropriately for safe shipment. The customer should enclose with the product, a copy of their receipt for proof of purchase and warranty. It is recommended that products are returned to point of purchase or be sent by registered mail as Century Yuasa Batteries accepts no responsibility / liability for goods lost or damaged in transit.

Exclusions:

If upon receiving a product for repair, the testing and examination of the product discloses that the alleged defect or malfunction in the product does not exist or was caused by the Customer or any third persons misuse, neglect, physical abuse, water damage, unauthorised attempts to open, exposure to extremely high temperatures, tampered with or repaired by an unauthorised person, this will not be covered under this warranty. Costs may be charged to the Customer in the event that the product returned has been tested and no fault found or the warranty has expired or been voided.

This Warranty is also void if:

1. The warranty seal is broken or altered.
2. The warranty period has expired.
3. The product has been tampered with or repaired by an unauthorised person.
4. If used on a generator without using a surge protector.

Our goods come with guarantees that cannot be excluded under the Australian Consumer Law. You are entitled to a replacement or refund for a major failure and compensation for any other reasonably foreseeable loss or damage. You are also entitled to have the goods repaired or replaced if the goods fail to be of acceptable quality and the failure does not amount to a major failure. For New Zealand customers, this warranty is in addition to statutory rights observed under New Zealand legislation.

Century Yuasa Batteries Pty Ltd
37-65 Cobalt Street, Carole Park,
QLD, 4300, Australia
T: 1300 362 287
www.centurybatteries.com.au



Century Yuasa Batteries (NZ) Ltd
259 Church Street, Onehunga,
Auckland, 1643, New Zealand
T: 0800 93 93 93
www.centurybatteries.co.nz

Approval No. GMA-511817-EA

CC1212-XLi Owner's Manual: Rev 1.0 - 04/22 - Specifications subject to change without notice.