

ToolPRO

PLU: 633603
CODE: TH91204A
Manufactured and packaged for
SRGS PTY LTD
ABN 23 113 230 050
6 Coulthards Avenue
Strathpine QLD 4500, Australia
MADE IN CHINA

ToolPRO

1 YEAR
WARRANTY

THIS BOTTLE JACK COMPLIES WITH VEHICLE JACK STANDARD
AS/NZS 2693:2007 AS AMENDED BY CONSUMER PROTECTION
NOTICE NO.1 OF 2010



8000KG
BOTTLE JACK

PLU 633603

WARRANTY

Our product is guaranteed to be free from quality and manufacturing defects for a period of 12 months.

If your product becomes defective during this period, SRGS PTY LTD will offer you either a replacement, credit or refund where a product is faulty; wrongly described; different from the sample shown to you or do not do what they are supposed to do.

This warranty will not cover substantially modified product; misuse or abuse of the product contrary to user instructions or packaging label; change of mind and normal wear and tear.

Our goods come with guarantees that cannot be excluded under the Australian Consumer Law. You are entitled to a replacement or refund for a major failure and for compensation for any other reasonably foreseeable loss or damage. You are also entitled to have the goods repaired or replaced if the goods fail to be of acceptable quality and failure does not amount to a major failure.

To claim the warranty, take the product to the front Service Desk of your nearest store of purchase. You will need to show receipt or other proof of purchase. Additional information may be required to process your claim. Should you not be able to provide proof of purchase with a receipt or bank statement, identification showing name, address and signature may be required to process your claim.

Any expenses relating to the return of your product to the store will normally have to be paid by you. For online store purchases, SRGS PTY LTD will pay for the return freight for any product assessed as having a major failure.

The benefits to the customer given by this warranty are in addition to other rights and remedies of the Australian Consumer Law in relation to the goods or services to which this warranty relates.

This warranty is provided by SRGS PTY LTD, 6 Coulthards Avenue, Strathpine QLD 4500, Australia. Phone: 1300 175 010.

OPERATION

TO RAISE:

1. Turn the release valve with the end of the handle clockwise until it is firmly closed before pumping.
2. Position the jack under the load and turn the extension screw or head cap until solid contact can be made with the load to be lifted.
3. Operate the jack handle until the head cap contacts the load. Once again, check to see that the head cap is correctly positioned.
4. After the load is lifted to desired height. Use appropriate means (e.g. vehicle support stands) to support the load immediately.

TO LOWER:

1. Raise the jack to remove the vehicle support stands or other supporting object.
2. Slowly turn the release valve counterclockwise (again using the handle) no more than ONE full turn. When under a load, the jack will lower to the original point of contact. If the piston is still extended, push the piston down manually so that the piston is not left exposed to rusting.

MAINTENANCE PROCEDURES

IMPORTANT:

- Do not use brake fluid, alcohol, glycerin, detergent, motor oil or dirty oil.
- Use a good grade Hydraulic Fluid (ISO 32 or equivalent).
- Improper fluid add ed can cause serious internal damage to the jack rendering it inoperative.

ALWAYS KEEP THE HYDRAULIC FLUID AT THE RECOMMENDED LEVEL.

TO ADD OIL:

With the head cap fully lowered and the piston depressed, place the jack horizontally and then remove the oil filler plug (refer to figure 1). Fill until oil is level with the filler plug hole when the jack is upright.

TO CHANGE OIL:

- For best performance and longest life, replace the complete oil supply at least once a year. To drain the oil, remove the filler plug. Lay the jack with oil filler hole downward and allow the oil to run out into a suitable drain pan. The oil will run slowly because air must enter as the oil drains out.
- **DO NOT** allow dirt or foreign matter to get into the system. Replace with the proper oil as described above.

LUBRICATION:

Add proper lubricant oil to all pivoting sections every 3 months.

PREVENTING RUST:

Check ram (B) every 3 months for any sign of rust or corrosion. Clean as needed by wiping with an oil cloth. When not in use always leave the head cap (A) and ram (B) all the way down.

HYDRAULIC SYSTEM COMPONENTS

- A. Head cap
- B. Ram
- C. Handle
- D. Release valve
- E. Oil filler plug
- F. Oil reservoir
- G. Screw Extension

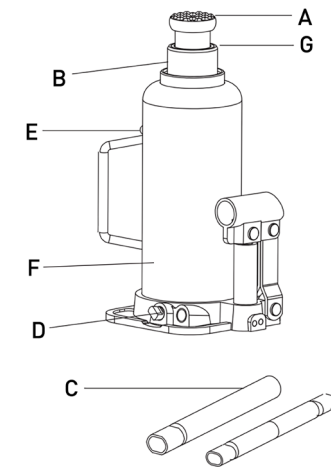

SAFE USAGE INSTRUCTIONS

Recommendations for safe usage of the jack:

1. The jack should be used on level firm ground wherever possible.
2. It is recommended that the wheels of the vehicle be chocked and that no person should remain in a vehicle that is being jacked.
3. No person should place any portion of their body under a vehicle that is supported by a jack.
4. The vehicle owner's manual should be consulted prior to the jacking of the vehicle and for further instructions.

IMPORTANT

Sometimes during shipment and handling, air gets trapped in the hydraulic system causing poor performance. This will usually happen when changing the oil. Purge any air from the system with the head cap fully lowered and the piston depressed, place the jack horizontally and then remove the oil filler plug. The air will escape through the filler hole.



WARNING: DO NOT GET UNDER A VEHICLE THAT IS SUPPORTED BY A JACK.

SPECIFICATIONS

HEIGHT LOWERED	230mm
HEIGHT RAISED	460mm
WORKING LOAD LIMIT	8000kg