



GRUNDIG

GX-3820

User Manual

6.8"
In Car
Display
Audio



Works with
Apple CarPlay

android
auto

Initial Setup



Please select the suitable Country Area/Language, Tap **Finish** button to confirm.

TIPS Perform this setup when you use this unit first time.

Overview Of The Unit

◆ Functions of the Buttons on the Head Unit



Overview Of The Unit

◆ Home Screen Descriptions



◆ Support USB Playback Mode

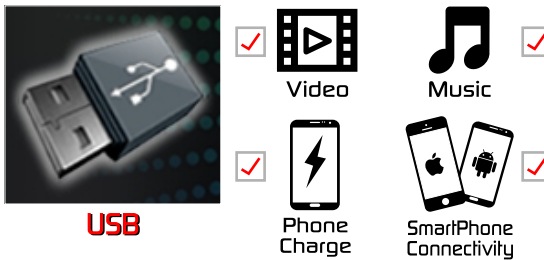

Overview Of The Unit

◆ View All Sources



Swipe left to display All Sources



◆ Shortcut

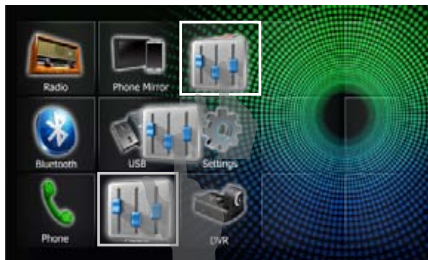

Tap and hold the icon and drag it to the shortcut area





Swipe left/right to display/hidden shortcut

◆ Widget



Swipe right to display widget



Tap  or  return to Now Playing mode

Radio Operation

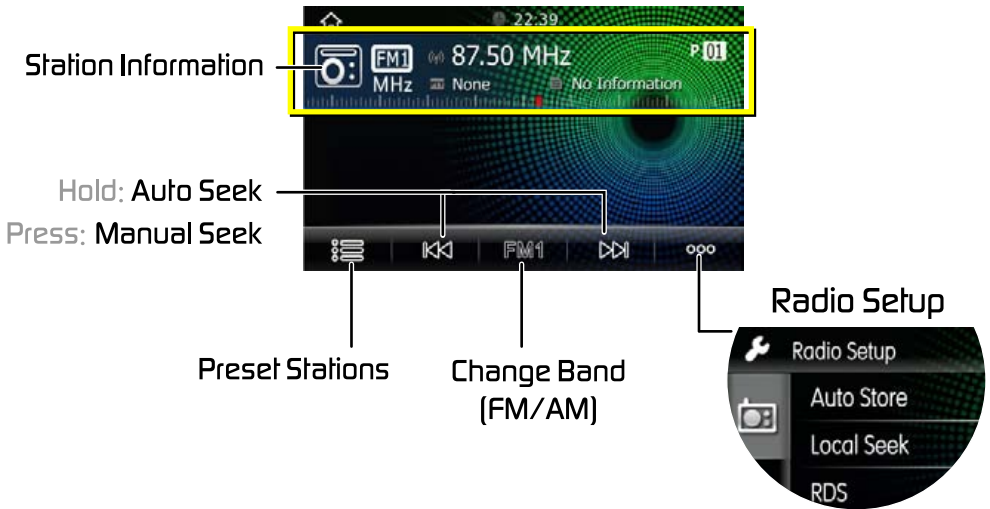

Radio Preset Station List

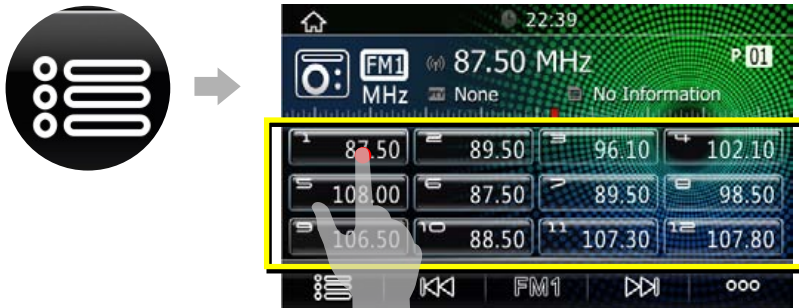

TIPS

Tap  to display the Preset list, tap again to hide.

USB Media Operation

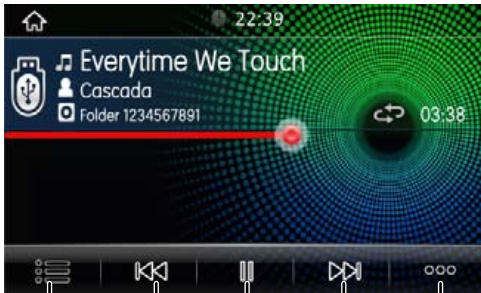

Play Content List Track Down Play/Pause Track Up USB Setup

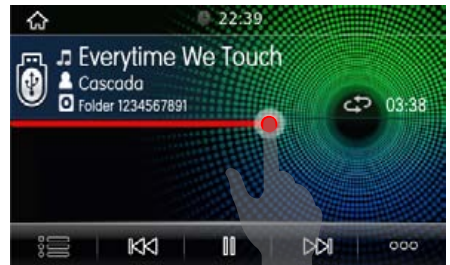

Drag to Fast Forward/Backward

USB Media Content List

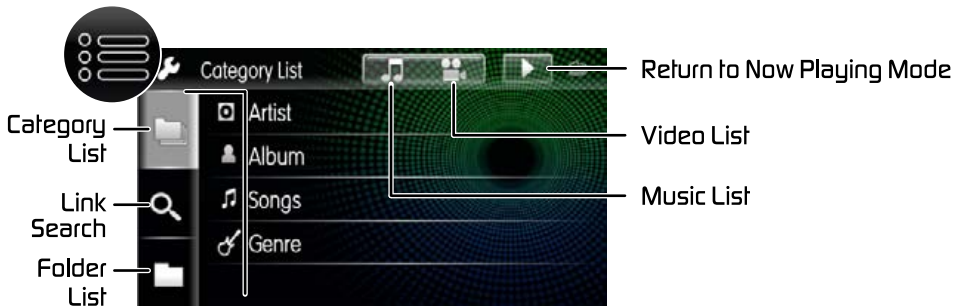

USB Album Art Wallpaper

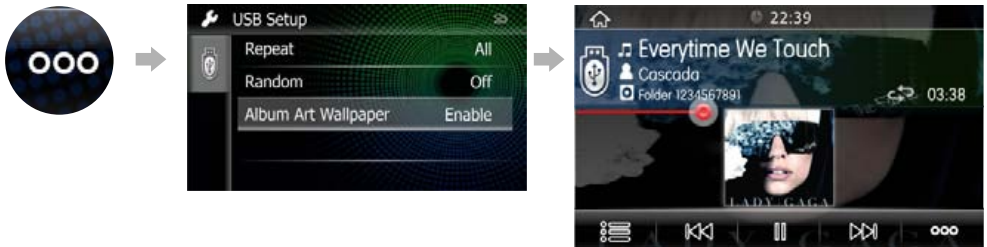

You can set the Album Art to the background image.

Tap **Enable** / **Disable** to enable/disable this function.

How To Pair the Device ?



Please search “GRUNDIG” and connect under bluetooth option of your phone.

Connect/Delete the Bluetooth Device

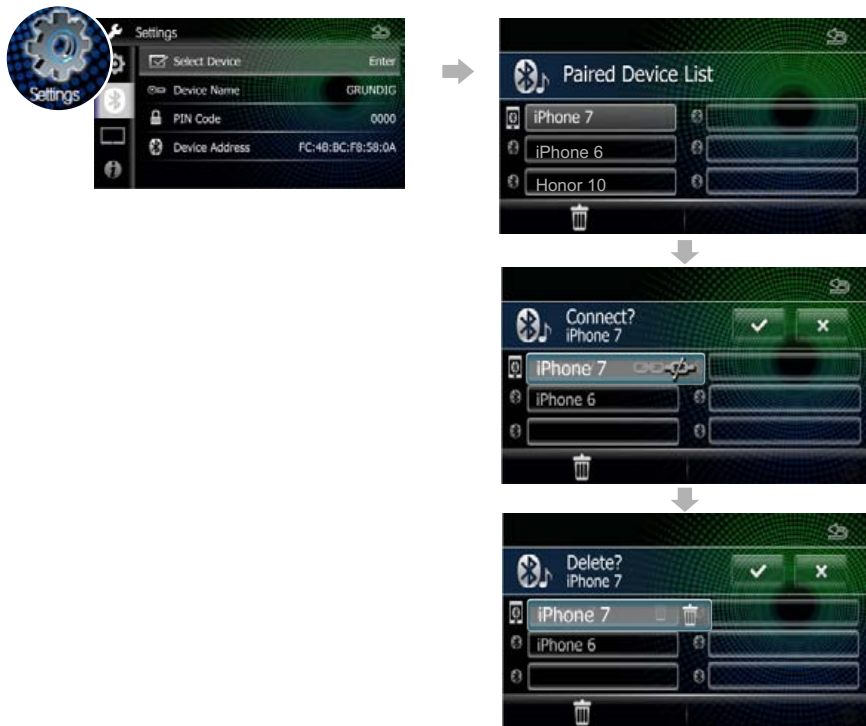

1. Tap **Select Device** in the bluetooth setup menu.
2. Touch the device name you want to connect/delete.

Phone Call



TIPS



To Download the Phonebook, please Authorize the request on your phone

Voice Assistant

You can access the voice recognition function of the phone connected to this Car Av System.



TIPS

- This function must be operated in a state before connection Bluetooth
- You can use voice recognition function by press and hold  on the front panel.
- Tap  to exit the Voice Control function.

Smart phone connectivity gives phone users an incredibly intuitive way to make calls, use maps, listen to music and access message with just a word or a touch.

- ◆ Please select the phone connectivity device from the menu setting



CarPlay



Android Auto



Android Mirror



iPhone Mirror

◆ Getting Start

1. Please use the USB cable to connect your phone and insert to the front USB host of the Car AV System. After connected ok, the smart phone connectivity icon will be lighted on.



2. Tap to start up.



TIPS

Before you use the smart phone connectivity, please go to phone mirroring settings to select smart phone connectivity device.

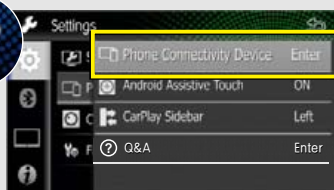

About Android Mirroring

Android Mirroring is a simpler way to direct mirror to use your phone in the Car AV System.

◆ Connect the Android Phone



TIPS

- If the smart phone connection to the Car AV System is not successful, please unplug and insert USB cable and try again.
- Compatible Android devices:
You can use Android Mirroring with devices of Android Version 5.0 or later.

◆ Install a App

- Autolink App is not installed.

When you connect the Android phone and the Car AV system by USB cable, the advisory message will pop up on your phone and the car AV system. Please follow it to install App.

Autolink

No installed apps work with this USB accessory. Learn more about this accessory at <https://play.google.com/store/apps/details?id=com.link.autolink>

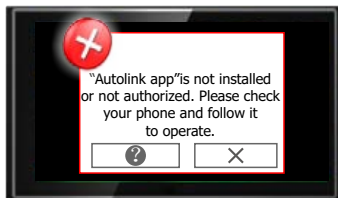

Press

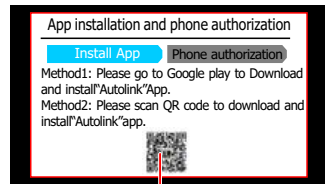

QR Code for install Autolink App

TIPS

Your phone must install the Autolink App and authorization, before you can use the Android Mirroring.

◆ Authorization

Please follow the pop up authorization prompt on your phone and complete the authorization

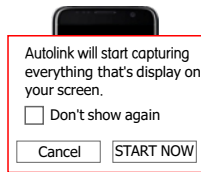

TIPS

If you want to have the authorization message on your phone, you can unplug & insert USB cable to try again.

How to setup Android Mirroring two way control?

◆ Bluetooth connect

Connect your phone to car AV system by USB cable, car AV system will connect bluetooth with your phone automatically. the Android Mirroring two way control will be activated once the bluetooth is connected successfully.



How to pop up the Android Assistive button?

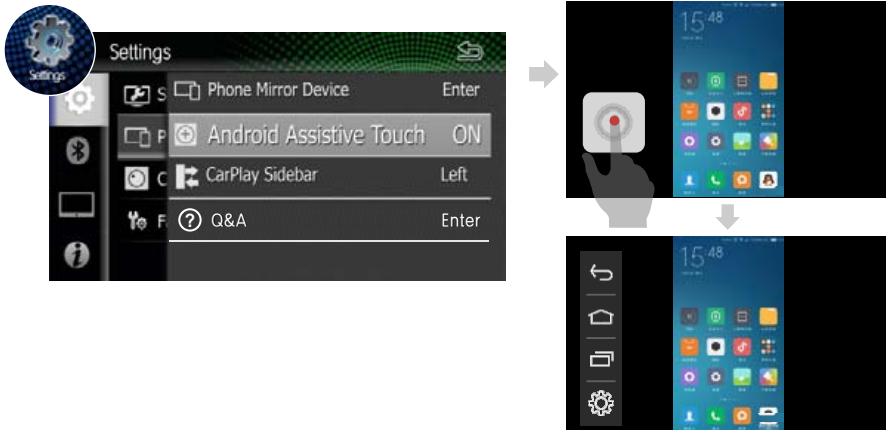

TIPS

- When in Android mirroring mode, if the operation is not supported, it will pop up the advisory message, you can click  button to check the detail information.
- About the Smart Phone Connectivity help, you can go to Settings/Phone Connectivity Device/Q&A to study.

About iPhone Mirroring

iPhone Mirroring is a simpler way to direct mirror to use your phone in the Car AV System

◆ Connect an iPhone



TIPS

- If the smart phone connection to the Car AV System is not successful, please unplug and insert USB cable and try again.
- Compatible iPhone devices:
You can use iPhone Mirroring with devices of iOS Version 8.0 or later.

◆ Authorization

Please follow the pop up authorization prompt on your phone and "trust" the device.

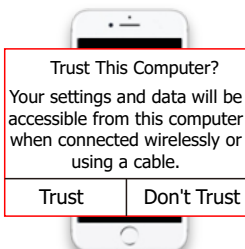

TIPS

- Your iPhone must "trust" the Car AV System before you use the iPhone Mirroring.
- If you close the authorization message on your phone, you can unplug & insert USB cable to try again.
- If your iPhone is iOS 11 version or above, maybe the iPhone music player and Video player sound can not output from the Car AV System. You can try use the third music player & video player.
- When in iPhone mirroring mode, if the operation not support will pop up the advisory message, you can click ? button to check the detail information.
- About the Smart Phone Connectivity help, you can go to Settings/ Phone Connectivity Device/Q&A to study.

About Apple CarPlay

CarPlay is a smarter, safer way to use your iPhone in the car. CarPlay takes the things you want to do with iPhone while driving and displays them on the screen of the product. You can get directions, make calls, send and receive messages, and listen to the music from iPhone while driving. You can also use Siri voice control to make it easier to operate iPhone.

TIPS

Some features, applications, and services are not available in all areas. For details, see: <http://www.apple.com/ios/carplay/>

◆ Connect an iPhone



TIPS

If iPhone CarPlay connection to the Car AV System is not successful, please unplug and insert USB cable and try again.

◆ Settings of Apple CarPlay

You can adjust the CarPlay Sidebar is show on left or right as below:

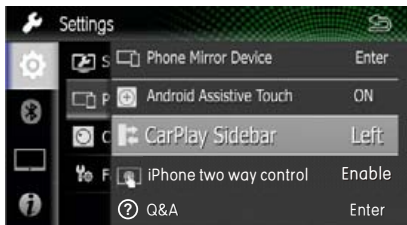

TIPS

Please unplug the USB cable after you change the CarPlay Sidebar option.

Operation of Apple CarPlay

◆ Operation button of Apple CarPlay



Hold to activate Siri.

Switch forward and backward between Apple CarPlay and Playback mode

◆ Operation button on CarPlay Home

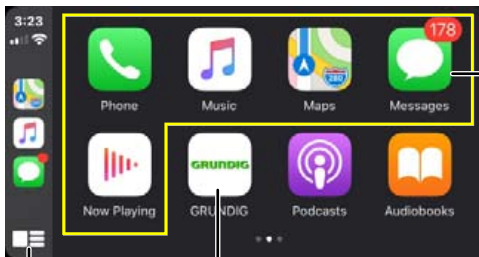

Application Buttons

Exits the CarPlay screen and displays the HOME screen

Hold: To activates Siri

Press: Display the home screen of CarPlay

About Android Auto

Android Auto enables you to use functions of your Android device convenient for driving. You can easily access route guidance, make calls, listen to music, and access convenient functions on the Android device while driving.

For details about Android Auto, visit the below address:

<https://www.android.com/auto>

<https://support.google.com/androidauto>.

TIPS

- **Compatible Android devices**
You can use Android Auto with Android devices of Android version 5.0(Lollipop) or later.
- Android Auto may not be available on all devices and is not available in all countries or regions.

◆ Connect Android phone



TIPS

If Android Auto connection to the Car AV System is not successful, please unplug and insert USB cable and try again.

◆ Initial setup Android Auto

When you use Android Auto first time, you must engage parking brake and follow the instructions to do on your phone.

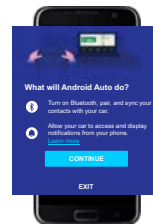
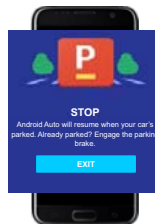
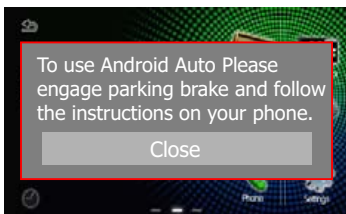

TIPS

You also can go to settings/System to set the Parking on to use the Android Auto.

Operation of Android Auto

◆ Operation button of Android Auto

Hold to activate Siri.
Switch forward and backward
between Apple CarPlay and
Playback mode



◆ Operation button on Android Auto Home

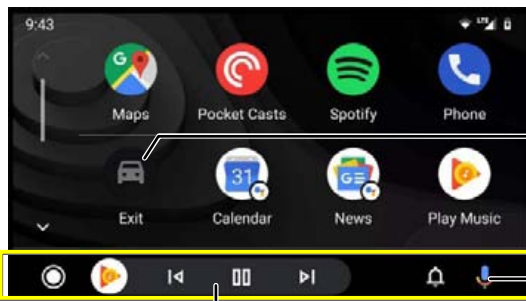

Return to Car Home

Google Assistant

Application/information buttons
Starts the application or displays information

◆ Voice only while driving

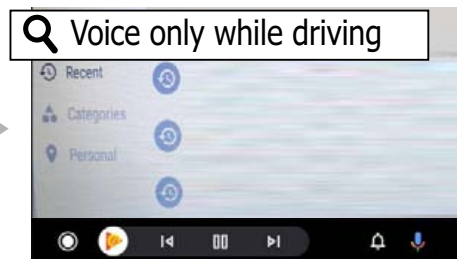
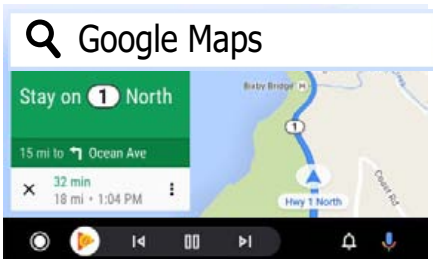

When you use handwriting, you must engage parking brake.

24 Bit DSP Audio Operation

You can adjust the various settings:



◆ 13 Band Equalizer



You can customize the equalizer, tap **User1** or **User2** to stored.



◆ Time Alignment



- Tap **Delay** to adjust the delay time of the selected speaker
- Tap **Level** to adjust the sound level of the selected speaker.

◆ Cross Over



- Tap **Tweeter** to set the virtual tweeter when you are selecting front speakers.
- Tap  to switch Front/Rear high pass filter function
- Tap  to switch Subwoofer low pass filter transfer function

◆ Virtual Subwoofer





- Turn the Rear Speakers to Virtual Subwoofer. Enjoy the powerful Bass without install any real subwoofer.

24 Bit DSP Audio Operation

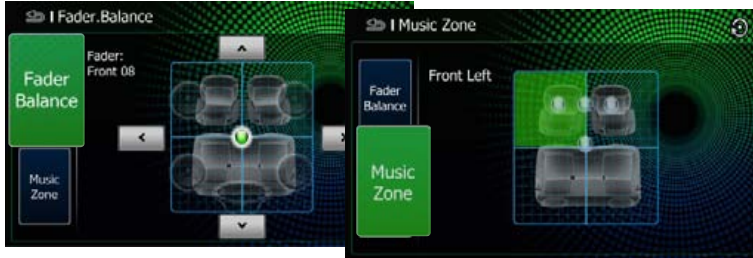
◆ Fader . Balance / Music Zone



- Tap  to adjust the volume balance around the touched area
- Tap  to select perfect listening position

◆ X-Bass

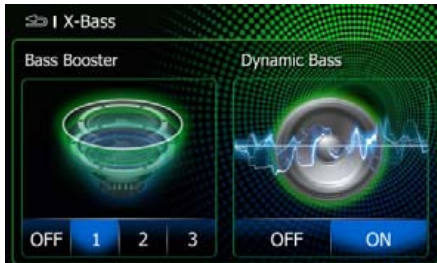

- Tap to Set the amount of bass boost, and set the amount of boost of low and high tones

TIPS Tap  resume to factory default value.

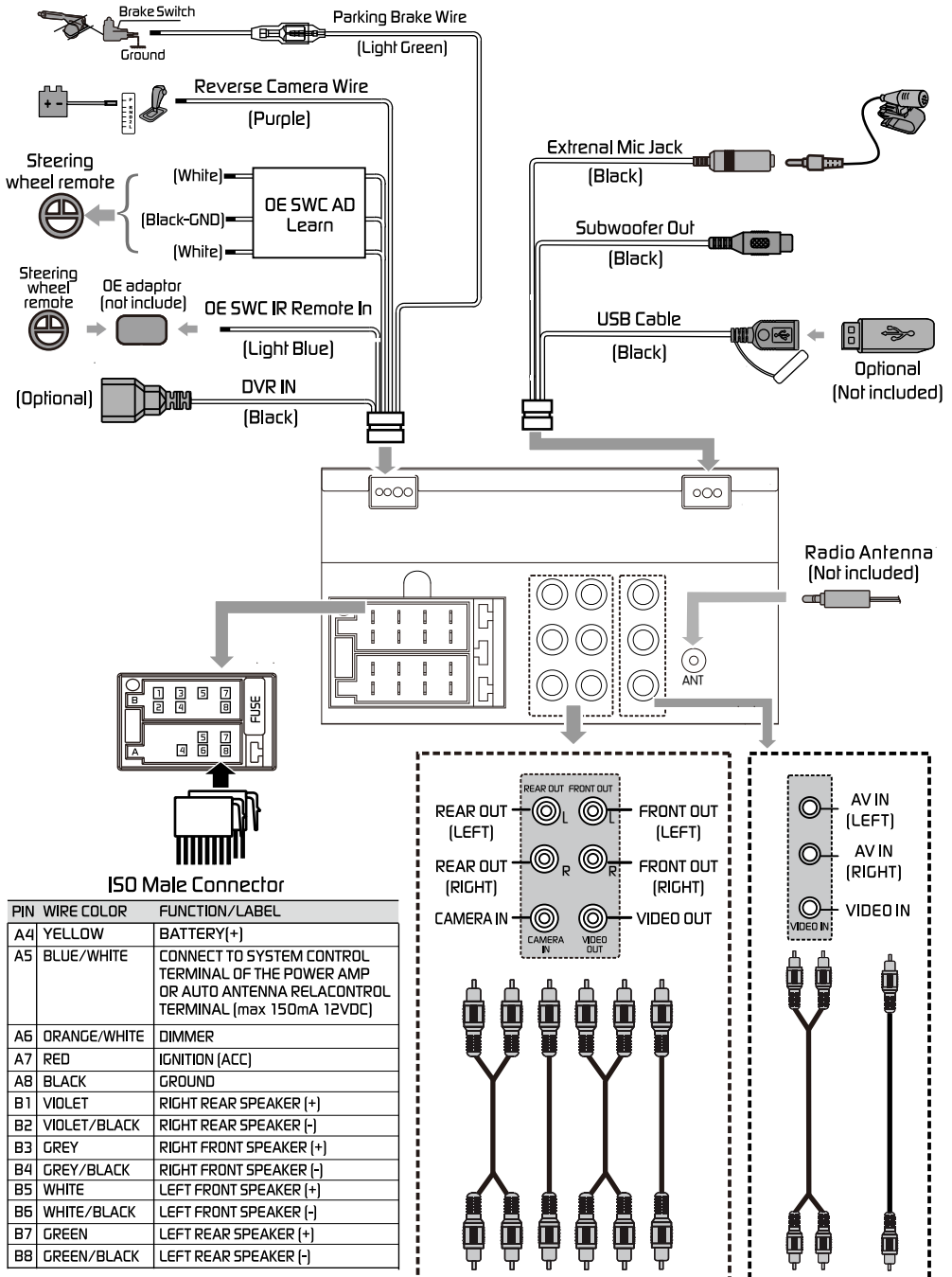

TFT Monitor section

Screen Size	: 6.8 inches
Display Resolution	: 1024x600 dots
Contrast Ratio	: 500

USB interface section

USB Standard	: USB 2.0 Full Speed
File System	: FAT 16/32
Maximum Current	: DC 5V --- 1.5A
D/A Converter	: 24Bit

Bluetooth section

Communication System	: Bluetooth Ver 4.1
Output	: Bluetooth Standard Power Class 2
Maximum Communication Range	: Approx. 10meters
Frequency Band	: 2.4 GHz
Compatible Bluetooth Profiles	: HFP/SPP/A2DP/AVRCP /PBAP
Supported Codecs	: SBC (Sub Band Codec)

Radio section

Frequency FM range	: 87.5-108.0MHz
Frequency AM(MW) range	: 522-1620 KHz
Usable sensitivity	: 13.2 μ V (FM) : 44.7 μ V (AM)(MW)

Video section

Color System of	: NTSC/PAL
External Video Input	
External Video Input (RCA/3.5m Jack)	: 1 Vp-p / 75 Ω

Audio section

Maximum Power	: 50Wx4
Continuous Power	: 22 Wx4
Output (RMS)	
Preout Level (V)	: 4V/10k Ω
Preout Impedance	: \leq 1.3k Ω
Speaker Impedance	: 4-8 Ω
Output Frequency Band	: 20-20000Hz

General

Operating Voltage	: 14.4V(10.5-16 V)
Operational Temperature Range	: -20° C--+80° C
Maximum Current Consumption	: 15A

Support Formats

Support Audio Formats

- MP3/WMA Bit rate: 16-320 Kbps, VBR
- WMA Version V9 or earlier
- ID3 Tag Version 1.0/1.1/2.2/2.3/2.4

Support Video Formats

- MPEG 1 (.mpg, mpeg), 720x480(30fps)
- MPEG 2 (.mpg, mpeg), 720x480(30fps)
- MPEG 4 (.mp4, avi), 720x480(30fps)

Support File / Folder Formats

- Directory nesting up to a maximum of 8 levels
- Number of tracks/titles: maximum 999
- Number of albums/folders maximum 99

GRUNDIG

FOR A GOOD REASON



Made in China