

TOUCH UP AIR SPRAY GUN



BLACKRIDGE

Manufactured and packaged for SRGS
PTY LTD ABN 23 113 230 050
751 Gympie Road, Lawnton, Queensland 4501, Australia

TOUCH UP AIR SPRAY GUN



**INSTRUCTION
MANUAL**

BLACKRIDGE

PLU 572928

WARRANTY

This product is guaranteed against defects for a period of (12 months) from date of purchase. This warranty is provided by SRGS PTY LTD ABN 23 113 230 050 of 751 Gympie Rd Lawnton QLD 4501 Ph (07) 3482 7500. Supercheap Auto will offer a repair, replacement product or store credit if the product is assessed as being defective during the warranty period.

To claim under this warranty, take this product to the Front Service Desk of your nearest Supercheap Auto store. For store locations, visit www.supercheapauto.com.au (AUS) or www.supercheapauto.co.nz (NZ). You will need your receipt or proof of purchase. Additional information may be requested of you to process your claim. Should you not be able to provide proof of purchase with a receipt or a bank statement, identification showing your name, address and signature may be required to process your claim.

This product may need to be sent to the manufacturer to assess the defect before determining any claim. Faults or defects caused by product modification, misuse and abuse, normal wear and tear or failure to follow user instructions are not covered under this warranty.

Our goods come with guarantees that cannot be excluded under the Australian Consumer Law. You are entitled to a replacement or refund for a major failure and for compensation for any other reasonably foreseeable loss or damage. You are also entitled to have the goods repaired or replaced if the goods fail to be of acceptable quality and the failure does not amount to a major failure.

Any expenses incurred relating to the return of this product to store will normally have to be paid by you. For more information contact your nearest Supercheap Auto store.

The benefits to the consumer given by this warranty are in addition to other rights and remedies of the Australian Consumer Law in relation to the goods and services to which this warranty relates.

ILLUSTRATION



TECHNICAL DATA

Model: F-2
Nozzle Size: 0.5mm (standard)
Recommended Operating Pressure: 43 PSI
Average Air Consumption: 50 LPM
Fluid Delivery: 0.02-0.08 LPM
Cup Size: 100ml
Air Inlet: 1/4"

WARNING

When using the tool, basic safety precautions should always be followed to reduce the risk of personal injury and damage to equipment. Please read all instructions carefully before using this tool.

- **WORK AREA CONDITIONS.** Cluttered areas invite injuries. Avoid any ignition sources, such as smoking, open flames and similar hazards.
- **ADDITIONAL WORK AREA CONDITIONS.** Do not use machines or powertools in damp or wet locations. Do not expose to rain. Keep work area illuminated.
- **KEEP CHILDREN AWAY.** Children should not be allowed in the work area. Donot let them handle machines, tools or extension cords.
- **STORE IDLE EQUIPMENT.** When not in use, tools must be stored in a dry location to inhibit rust or corrosion. Always lock up tools and keep out of reach of children.

- **USE THE RIGHT TOOL FOR THE JOB.** Always use the tool for the specific purpose it was intended.
- **DRESS PROPERLY.** Always wear the appropriate clothing suited to the painting application.
- **WEAR EYE PROTECTION.** Always wear appropriate eye protection when operating a spray gun.
- **DO NOT OVER-REACH.** Keep proper footing and balance at all times. Do not reach over or across running machines.
- **STAY ALERT.** Watch what you are doing and use common sense. Do not operate any tools when you are tired.
- **CHECK FOR DAMAGED PARTS.** Before using any tool, any part that appears damaged should be carefully checked to determine if it will operate properly and perform its intended function. Any part that cannot fulfill its intended purpose should be replaced.
- **REPLACEMENT PARTS AND ACCESSORIES.** When servicing, use only identical replacement parts.

OPERATION

Preparation before operating:

- Check and replace any damaged or wrong parts.
- Make sure the nozzle and air trigger are free to operate correctly.
- Attach paint pot to the spray gun.
- Pour paint into paint pot and fit lid securely.

WARNING: When filling or refilling the material, disconnect your gun from the air supply to avoid accidental spillage or spraying.

Operating:

Recommended air line components (for best results you should incorporate an air regulator with filter).

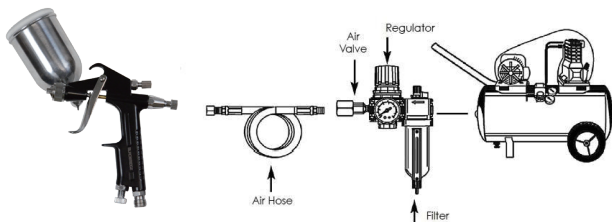

- Connect the air source hose to the gun. Make sure the air pressure does not exceed 43 PSI.
- Pull the trigger slowly and move the spray gun in parallel strokes to the object being painted. Keep the distance from the object being painted at 15-30cm. This may slightly differ depending on the flow adjustment and the material being sprayed.
- Release the trigger after each forward movement; pull the trigger again on the return movement.
- When using a vertical pattern, move the spray gun in a horizontal motion. When using a horizontal pattern, move the spray gun in a vertical motion. A round pattern requires a greater distance from the object being painted.

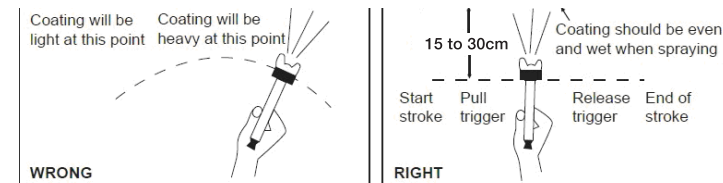





- When finished, release the trigger and disconnect from the air source. The spray gun may still have pressure; point the spray gun towards scrap material and pull the trigger until all of the pressure is exhausted.

MAINTENANCE

- Pour remaining paint into another container and then clean paint pot and air nozzle. Spray a small amount of thinner to clean the passage. Incomplete cleaning will cause an adverse pattern shape when spraying. Clean thoroughly, immediately after use.
- Clean other sections with a cloth, soaked with thinner.
- Ensure paint passages have been fully cleaned before disassembly.
- Remove fluid nozzle after removing fluid needle set or while keeping fluid needle pulled, in order to protect the seat section.

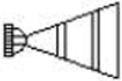
CAUTION: Never use wire or other hard objects to clear the nozzle and clean the fluid needle. This will cause damage to the components. Never immerse the whole gun into solvent such as thinner as it will damage the air nozzle, fluid nozzle and needle.

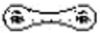
TROUBLESHOOTING

SPRAY PATTERN	REASON	SOLUTION
 Ring or Fluttering	Air enters between the fluid nozzle and tapered seat of the gun body.	Remove the fluid nozzle and clean the seat. Replace if damaged.
	Air enters near the needle sealing nut.	Tighten the needle sealing nut.
	Air enters between material passage connector and cup.	Assemble and tighten the relative parts again after cleaning.
 Crescent	Paint build up on air nozzle partially clogs horn holes. Air pressure from each horn is different.	Remove obstructions from horn holes. Do not use metal objects to clean horn holes.
 Inclined	Paint build up on the periphery of the fluid nozzle hole or centre hole of air nozzle damaged.	Remove obstructions or replace if necessary.
	Loose fluid nozzle.	Remove fluid nozzle, clean and replace.
 Split	Paint viscosity too low.	Add paint to increase viscosity.
	Fluid output too high.	Adjust the fluid adjustment knob or pattern adjustment knob.
 Heavy	Paint viscosity too high.	Add thinner to reduce viscosity.
	Fluid output too low.	Adjust the spray adjustment valve to allow more fluid output.

PARTS LIST

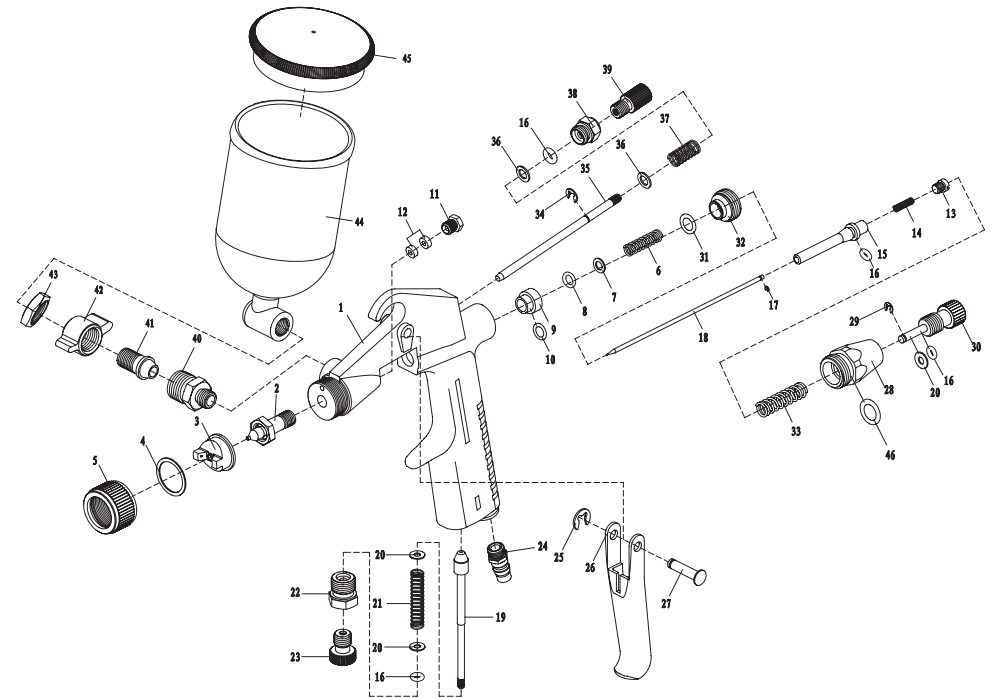

NO.	Description	Quantity	NO.	Description	Quantity
1	Gun body	1	24	Air joint	1
2	Material nozzle	1	25	Opening stopper 3	1
3	Air nozzle	1	26	Trigger	1
4	Air nozzle gasket	1	27	Trigger pin	1
5	Locking knob	1	28	Needle adj.seat	1
6	Spring	1	29	Opening stopper 2	1
7	Gasket	1	30	Needle adj.knob	1
8	O ring 4 x 1.8	1	31	O ring 6.0 x 1.8	1
9	Sealing plug	1	32	Spring seat	1
10	O ring 5 x 1.5	1	33	Needle adj.spring	1
11	Sealing screw	1	34	Opening stopper 2.5	1
12	Sealing gasket	2	35	Pattern adj.stem	1
13	Screw	1	36	Pattern adj.Gasket 3	2
14	Needle spring	1	37	Pattern adj.spring	1
15	Needle sleeve	1	38	Pattern adj.seat	1
16	O ring 2.5 x 1.8	4	39	Pattern adj.knob	1
17	Opening stopper 1	1	40	Material passage connector	1
18	Needle set	1	41	Connector screw	1
19	Airflow adj.stem	1	42	Connector nut	1
20	Airflow adj.Gasket 3	3	43	Hexagon locking nut	1
21	Airflow adj.spring	1	44	Cup	1
22	Airflow adj.seat	1	45	Cup cover	1
23	Airflow adj.knob	1	46	O ring 8 x 1.5	1

NOTE:

When spray painting consider the size of the job and the size of your air compressor being used. When spray painting large jobs like a fence or car, a Belt Drive Air compressor is recommended. Always refer to the duty cycle of your air compressor before spray painting.