

STANLEY®

PETROL PRESSURE WASHER 6.5HP 3200PSI



MODEL NO.
SXPW7032BS

For service, spare parts or product information,
please contact Smart Marketing Group Pty. Ltd.

AUST. 1300 660 457 N.Z. 0800 474 876

SUGGESTED APPLICATIONS

These are some suggested applications where you could use your pressure washer:

- Concrete driveway
- Paved area
- Car
- Motorbike
- Truck
- Wall
- Garden feature



IMPORTANT

OIL (CHECK DAILY - ONLY USE 4 STROKE MOTOR OIL)

This pressure washer is fitted with a Briggs & Stratton engine. Please refer to the enclosed Briggs & Stratton Engine Manual for details on warranty and servicing.

CONTENTS

Section	Page
Contents	2
Suggested Applications	2
Introduction	3
Warranty	3 – 4
General Safety Instructions	5 – 7
Specific Safety Instructions	8
Fuel & Oil Information	9
Components and Controls	10
Assembly Instructions	11 – 12
Operating Instructions	13 – 16
Cleaning Tips	17
Maintenance	18 – 19
Trouble Shooting	20
Parts Diagram	21
Service Log	22
Technical Information	23
Contact Information	24

2 YEARS WARRANTY
DOMESTIC

1 YEAR WARRANTY
COMMERCIAL

Please take note of serial number and write here for ease of reference:

Serial Number: _____

Date of Purchase: _____

Place of Purchase: _____

Receipt Number: _____

INTRODUCTION

Dear Customer,

Thank you for purchasing this pressure washer which has passed through our extensive quality assurance processes. Every care has been taken to ensure that it reaches you in perfect condition. However, in the unlikely event that you should experience a problem, or if you require any assistance, please do not hesitate to contact us;



If you have a problem, call customer service do not return this pressure washer to the place of purchase.

NOTE: For convenience we suggest taking a photocopy of your purchase receipt as the original may fade.

CUSTOMER SERVICE

Australia: 1300 660 457

New Zealand: 0800 474 876

Operating times: Monday – Friday

8.00am - 5.00pm

Australian Eastern Standard Time (AEST)

Due to continual product development, the product you purchase may differ slightly from the one shown here.

EXPRESS WARRANTY STATEMENT - PRESSURE WASHER

You are not required to do anything to register your pressure washer purchase. Please attach the purchase receipt to this manual and ensure both are kept safe. We hope you enjoy your new pressure washer, and if you have any problems call customer service on the above phone numbers. Do not return to place of purchase.

Smart Marketing Group Pty Ltd (SMG) warrants that this pressure washer will be free from manufacturing faults or defects for 24 months, Domestic Use or 12 months, Commercial Use, from the date of purchase, providing original purchase receipt is kept and shown when needed and is subject to the terms and conditions below.

If a warranty fault appears within the warranty period, SMG reserves the right to replace or repair the product. In the event that SMG chooses to replace the product, this original warranty will expire at the original date of purchase. If the product includes various accessories or components, only the defective accessory or component will be replaced or repaired.

SMG reserves the right to replace defective parts of the product with parts and components of similar quality, grade and composition where an identical part or component is not available.

Products presented for repair may be replaced by refurbished products of the same type rather than being repaired. Refurbished parts may be used to repair the products.

What is covered.

- Manufacturing fault or defect.

How to claim under this warranty.

- Call customer service.
- Ensure you have the following: Original purchase receipt, Model of pressure washer, Serial number of pressure washer.
- Discuss the issue.
- Customer service will advise which authorised service agent to take the pressure washer to provided the issue is a warranty one.
- Take pressure washer to authorised service agent for repair.

What is not covered.

- Use of Pressure Washer for hire.
- Damage due to running dry or caused by dirty water.
- Damage caused by incorrect oil
- Damage caused by incorrect fuel or use of E10 ethanol fuel.
- Damage or deterioration due to transport.
- Damage caused by negligence, misuse, abuse or accident or incorrect voltage and wattage.
- Any corrosion or rusting.
- Damage caused by incorrect set up and start up.
- Replacement parts due to general wear and tear.
- Pressure washers with serial number defacement, modification or removal.
- Pressure washers which have been serviced by other than an authorised SMG service agent.
- Pressure washers with no original purchase receipt.
- Pressure washers which have been on sold, not original purchaser.
- Damage due to non-servicing of pressure washer as is required by this manual.
- Blockages / damage caused by dust, dirt, spiders webs or insects.
- Damage caused by the incorrect fitting of accessories.
- Damage caused by overloading, overworking the pressure washer.
- Damage to attached equipment or third party accessories.
- Damage caused by attached equipment or third party accessories.
- Loan unit whilst warranty servicing is carried out.
- Loss of income due to warranty servicing.

CONTACT DETAILS

Smart Marketing Group Pty Ltd
33-35 Lionel Road, Mt. Waverley
Victoria 3149, Australia.
Tel (+613) 9543 7266
Fax (+613) 9543 9839
service.group@sitro.com.au

COMPLETE WARRANTY STATEMENT – PRESSURE WASHER

As soon as you have purchased the pressure washer, we recommend that you check to make sure it is intact and that you read the operating instructions carefully before using it. The purchase receipt for this product is to be retained and must be presented if making a claim under the terms of the Smart Marketing Group (SMG) warranty. Bank account statements are not acceptable for proof of purchase.

This warranty does not cover pressure washers intended for hire. The warranty will under no circumstances extend to reimbursement or payment of damages, whether direct, indirect or consequential. The warranty is void if there is evidence the pressure washer has been modified or tampered with in any way or used with unauthorised accessories without our consent.

SMG declines any responsibility or liability whatsoever arising from misuse or abuse, negligent handling of the pressure washer or if the product has not been installed or failure to comply with the relevant safety, operating, setting and maintenance instructions (see further in this manual).

The warranty does not extend to installation or disconnection costs. The warranty does not cover a loan unit or recompense of loss of income while unit is being assessed, serviced or replaced.

Any item sent freight forward/collect for repair will be refused. Warranty repairs are free of charge, provided the appliance is delivered to our service department or authorised service agent. The pressure washer will need to be returned, adequately protected in a box. SMG will not be responsible for any in-transit loss or damage. Assistance under the warranty will only be made available if the request is made to our customer service team on the contact numbers listed below and proof of purchase is provided.

This is a repair only warranty you will need to take the pressure washer to the authorised service agent after contacting our customer service centre.

If the product includes various accessories or components, only the defective accessory or component will be replaced or repaired.

SMG reserves the right to replace defective parts of the product with parts and components of similar quality, grade and composition where an identical part or component is not available.

Products presented for repair may be replaced by refurbished products of the same type rather than being repaired. Refurbished parts may be used to repair the products.

Damage caused by third party accessories is not covered under this warranty.

Damage caused to attached equipment or third party accessories will not be covered under this warranty.

Rust and corrosion are not covered under this warranty.

If a warranty fault is found, the freight cost will be credited to the owner. If no fault is found, the product will be returned and any costs associated with the service will be charged to the owner.

Blockages caused by spider webs, insects, dirt, accumulated dust or incorrect oil are not covered by warranty. SMG reserves the right to replace or repair the appliance within the warranty period. Parts found to be defective due to a manufacturing default will be replaced free of charge.

In the event of SMG choosing to replace the appliance, the warranty will expire at the original date of purchase. If no warranty fault is found the owner will be advised and the product will be returned and any costs associated with the service will be charged to the owner.

Our goods come with guarantees that cannot be excluded under the Australian Consumer Law. You are entitled to a replacement or refund for a major failure and for compensation for any other reasonably foreseeable loss or damage. You are also entitled to have the goods repaired or replaced if the goods fail to be of acceptable quality and the failure does not amount to a major failure. The benefits of this warranty are in addition to any rights and remedies imposed by Australian State and Federal legislation that cannot be excluded.

In New Zealand, this SMG warranty is in addition to the conditions and guarantees which are mandatory as implied by the New Zealand Consumer Guarantee Act 1993. For service, spare parts or product information please contact customer service:

Australia: 1300 660 457

New Zealand: 0800 474 876

CONTACT DETAILS

Smart Marketing Group Pty Ltd

33-35 Lionel Road, Mt. Waverley

Victoria 3149, Australia.

Tel (+613) 9543 7266

Fax (+613) 9543 9839

service.group@sitro.com.au

LUBRICATION OF ENGINE

OIL (CHECK DAILY - ONLY USE 4 STROKE MOTOR OIL)

This pressure washer is fitted with a Briggs & Stratton engine. Please refer to the enclosed Briggs & Stratton Engine Manual for details on warranty and servicing.

ASSEMBLY

This pressure washer **MUST** be fully assembled by you prior to use. Failure to do so will result in the warranty being VOID. Failure to fully assemble this pressure washer may also result in personal injury.

SAFETY

Before attempting to operate this pressure washer the following basic safety precautions should be taken to reduce the risk of fire, electric shock and personal injury. It is important to read the instruction manual and to understand applications, limitations and potential hazards associated with this pressure washer. It is important that you read, understand and follow these instructions very carefully. This pressure washer is not intended for use by persons (including children) with reduced physical, sensory or mental capabilities, or lack of experience and knowledge, unless they have been given supervision or instruction concerning the use of the appliance by a person responsible for their safety.

BEWARE OF CHILDREN & PETS

Children and pets should be kept out of the operating area. Children should not be allowed to touch or operate pressure washers. All pressure washers should be kept out of reach of children. When NOT in use keep the pressure washer preferably stored or locked in a secure well ventilated cabinet or room with the fuel tank empty.

FUEL - UNLEADED 91 PETROL (NO ETHANOL)

Fuel used in this pressure washer is poisonous. Always wear approved breathing protection when decanting fuel. If you get any fuel on your skin or clothes wash the affected area immediately with soap and water and change your clothes. If you get fuel in your eyes wash immediately with clean water and seek medical attention. If any fuel is swallowed DO NOT induce vomiting, seek immediate medical attention.

WORK AREA

Work areas and benches should be kept tidy. Cluttered benches and work areas can cause accidents. Floors should be kept clean and free from rubbish. Special care should be taken when the floor is slippery due to sawdust or wax. Always leave sufficient distance, at least 5 metres between the pressure washer and the work area, especially when using tools designed for sanding or spraying liquids. As this pressure washer uses a petrol engine, only run the pressure washer outdoors or in a well ventilated area. If needed use a longer air hose to reach your work area.

OPERATING ENVIRONMENT

ALWAYS use your pressure washer in an open well ventilated area. Do not expose your pressure washer to rain. Do not expose your pressure washer to direct sunlight. Keep the work area well lit. Do not use your pressure washer in areas where there is a risk of explosion or fire from combustible materials, flammable liquids, paint, varnish, petrol, etc flammable gases and dust of an explosive nature. As a precaution it is recommended that you consult an expert on selecting and using a suitable fire extinguisher and have it available for use in an emergency when operating the pressure washer.

SELECT A PRESSURE WASHER WITH A SUFFICIENT RATING

Select the right pressure washer for the job. Do not use a pressure washer to do a job for which it was not designed. Do not force a small pressure washer to do the job of a heavy duty pressure washer. Any damage caused by overloading will void the warranty. Do not use pressure washers for purposes not intended.

HOT COMPONENTS

Beware, many of the components will get hot during use. Never touch any of the metal pipes, pump or motor as these may burn. In particular ensure that the high pressure hose does not touch the hot muffler either during use or when storing as it will damage the high pressure hose and this will not be covered under warranty.

MAINTAIN YOUR PRESSURE WASHER WITH CARE

When not using your pressure washer ensure the fuel choke is 'OFF'. Never leave the fuel choke 'ON' as this can damage the carburettor. Follow the instructions for lubricating and changing accessories. Keep handles clean, dry and free from oil and grease. Ensure that ventilation slots are kept clean and free from dust at all times. Blocked ventilation slots can cause overheating and damage to the motor. Ensure that the air and fuel filters are kept clean at all times.

STOP PRESSURE WASHER

Ensure that the pressure washer has stopped and is turned off when not in use, before servicing, lubricating, making adjustments or when changing any accessories.

REMOVE ADJUSTING KEYS AND WRENCHES

Form the habit of always checking to see that any adjusting keys or wrenches have been removed from the pressure washer before operating.

FIRE PRECAUTIONS

Always contact your fire authority before using the pressure washer on fire restricted days. It is not recommended to use your pressure washer when a total fire ban is in force. Never refuel your pressure washer while it is still running. As a precaution, it is recommended that an expert is consulted on obtaining and using a suitable fire extinguisher.

CLEANING YOUR PRESSURE WASHER

Always stop your pressure washer before you commence cleaning the unit. Always ensure that your pressure washer has cooled, about one (1) hour, before cleaning and storing. When cleaning your pressure washer use only a damp soft cloth. NEVER use liquid or solvents of any type.

All areas can be wiped down once cooled

RISK OF DAMAGE

Damage may occur if nozzle is used too close to appliance being cleaned. Always trial test the pressure washer on an inconspicuous part of the appliance. Beware poor paint and rust as the water will lift poor paint and cause rust spots to grow. Damage caused by pressure washer is not covered by warranty.

CHECK DAMAGED PARTS

Before using the pressure washer it should be carefully checked to determine that it will operate properly and perform its intended function.

Check for broken or missing parts and have them replaced or repaired at an authorised service facility. Check any other condition that may affect the operation of the pressure washer. A guard or any other part of the pressure washer that is damaged should be properly repaired or replaced by an authorised service facility unless otherwise indicated in this instruction manual.

Any switch that does not operate correctly must be replaced by an authorised service facility.

DO NOT use the pressure washer if the 'ON / OFF' motor switch does not turn the pressure washer 'ON' and 'OFF'.

PERSONAL SAFETY

Clothing

Do not wear loose clothing, jewellery or anything that could get caught in moving machinery.

Hair

Long hair should be tied back or contained in a protective covering.

Eye Protection

The use of safety goggles is highly recommended (normal glasses are not sufficient for eye protection) when using or refuelling pressure washers. Prescription glasses do not have safety lenses.

Footwear

Where there is the risk of heavy objects or if there is a risk of slipping on wet or slippery floors, suitable non-slip covered safety footwear should be worn. Protect your feet from dropping accidents.

Ear Protection

The use of ear protection is highly recommended when using pressure washers. The continual noise may damage your ears.

Respiratory Protection

Always wear approved breathing protection when decanting fuel. ALWAYS use this pressure washer in a well ventilated area. NEVER use indoors. WARNING! DO NOT breathe in exhaust fumes. Exhaust fumes are poisonous and may cause drowsiness, unconsciousness and even death. When operating any machinery that creates dust or when spray painting, an approved dust / filter mask must be worn. When machining concrete, man-made fibres, especially MDF (Medium Density Fibre board), the resin used in these materials can be hazardous to your health. Use an approved face mask with replaceable filter.

Do Not Over Reach

Do not over reach. Keep a proper footing and maintain your balance at all times. Avoid using abnormal stances and awkward body positions.

Stay Alert

Watch what you are doing, use common sense and never operate a pressure washer when you are tired, drinking alcohol, taking drugs or if taking medication that causes drowsiness.



WARNING

Only use pressure washer when fully assembled.

Do not attempt to modify the pressure washer in any way; this will VOID your warranty.

The use of any attachment or accessory other than those recommended in this instruction manual could result in damage to the pressure washer and could cause injuries to the operator.

This petrol pressure washer complies with Australian / New Zealand and International standards and safety requirements. Repairs should only be carried out by qualified persons using original spare parts. Failure to do so may result in considerable danger to the operator.

SPECIFIC SAFETY INSTRUCTIONS

Warning! Do not use the pressure washer in areas where there is a risk of explosion or fire from combustible materials. The sparks possibly caused when using this pressure washer may ignite combustible materials as well as flammable liquids, paint, varnish, petrol, flammable gases and dust of an explosive nature. As a precaution it is recommended that you consult an expert on a suitable fire extinguisher and its use. Ensure that the work area is kept clear of combustible materials.

Warning! Do not use the pressure washer indoors or in confined spaces where exhaust gases, smoke or fumes could reach dangerous concentrations.

- Fully assemble pressure washer before use
- Always use the pressure washer in an open well ventilated area.
- Ensure pressure washer is fully assembled before use.
- Unit will become hot during use. Please keep pressure washer at least one metre (1m) away from buildings, other equipment, pedestrian areas or flammable materials.
- Never pull the re-coil starter once the pressure washer engine has started. Any damage caused will not be covered by warranty.
- Ensure the pressure washer has stopped before servicing, or lubricating etc.
- Do not attempt to modify the pressure washer, guards or the supplied accessories in any way.
- Do not touch the exhaust. This can become very hot during operation and can cause serious burns.
- Do not allow high pressure hose to touch the muffler. Damage will occur and will not be covered by warranty.
- Always check the pressure washer for damaged parts or fuel leaks, ensure these are fixed before using it.
- Never refuel while smoking or in the vicinity of an open flame.
- Always wear safety eye wear, ear and breathing protection when operating or refuelling the pressure washer.
- To avoid a fire if you spill fuel while refuelling, clean up before starting the pressure washer.
- Never operate or store the pressure washer on its side, ALWAYS operate or store in an upright manner on firm, solid ground.
- Ensure that the pressure washer has stopped and turned off when not in use, before servicing, lubricating, making changes and when changing attachments such as air hoses / tools.
- Do not attempt to modify the pressure washer, guards or the supplied accessories in any way.
- Your pressure washer is factory set, NEVER attempt to speed it up as this could endanger the user and damage the pressure washer and/or attached appliances.
- If the pressure washer makes an unfamiliar sound or vibrates excessively, switch the pressure washer 'OFF' immediately. Investigate the possible cause or consult your authorised service agent.
- Never use coolant in the pressure washer as damage may occur.
- Never transport the pressure washer with fuel in the tank. ALWAYS empty the fuel tank.
- Do not tamper or alter any parts as this may cause personal injury or damage the pressure washer.
- Never point gun/lance at people or animals.
- Never hose or wet people or animals.
- Never spray the pressure cleaner.
- Never spray electrical connections, electrical outlets or electrical appliances/fixtures.
- Never operate the pressure washer without water, any damage caused will not be covered by warranty.
- Never use hot water.
- Maximum water temperature is 35°C.
- Only use cold water with this pressure washer.
- Bystanders or people watching must be at least 10m away from the operating pressure washer.
- Only use clean water with this pressure washer.
- Never pump acids, alkaline, solvents or flammable liquids through this pressure washer, any damage caused will not be covered under warranty.
- Never allow the high pressure hose to touch the muffler or motor, as these hot surfaces will damage the hose. Damage caused will not be covered under warranty.
- Do not keep motor running if not using the wand. Damaged caused will not be covered under warranty.
- Inlet water hose size must be at least 12mm diameter.
- Inlet flow rate must be at least 18 L/min and mains pressure.
- Damage may occur if pressure washer nozzle is held too close to the cleaning surface. Damage caused will not be covered under warranty.
- Always trial the pressure washer and selected nozzle on an inconspicuous part of the appliance or surface to be cleaned.

IMPORTANT



FUEL - ONLY USE UNLEADED 91 PETROL (ULP - 91RON) - NO ETHANOL

Fuel tank capacity – 3.1 litres (3.1 L)

Use of incorrect fuel and/or oil may damage the pressure washer and will not be covered under warranty.

Do not use E10 or any type of ethanol fuel as this will damage the pressure washer and will not be covered under warranty.

Do not use high octane fuels (greater than 91%) as this will damage the pressure washer and will not be covered under warranty.

- Ensure you use clean fresh unleaded petrol (ULP) - No Ethanol.
- Use a clean approved container to store your unleaded petrol (ULP) in before decanting into the fuel tank.
- If contaminated (dirty) or old (stale) fuel is used, any damage caused will not be covered under warranty.



OIL (CHECK DAILY - ONLY USE 4 STROKE MOTOR OIL)

This pressure washer is fitted with a Briggs & Stratton engine. Please refer to the enclosed Briggs & Stratton Engine Manual for details on warranty and servicing.

To operate, this pressure washer requires oil in the sump, not supplied. If the pressure washer does not have the correct level of oil in the sump, it will not run, see note below.

Always check the oil level before starting the pressure washer.

Never check or add oil while the pressure washer is running.

PIC. 1

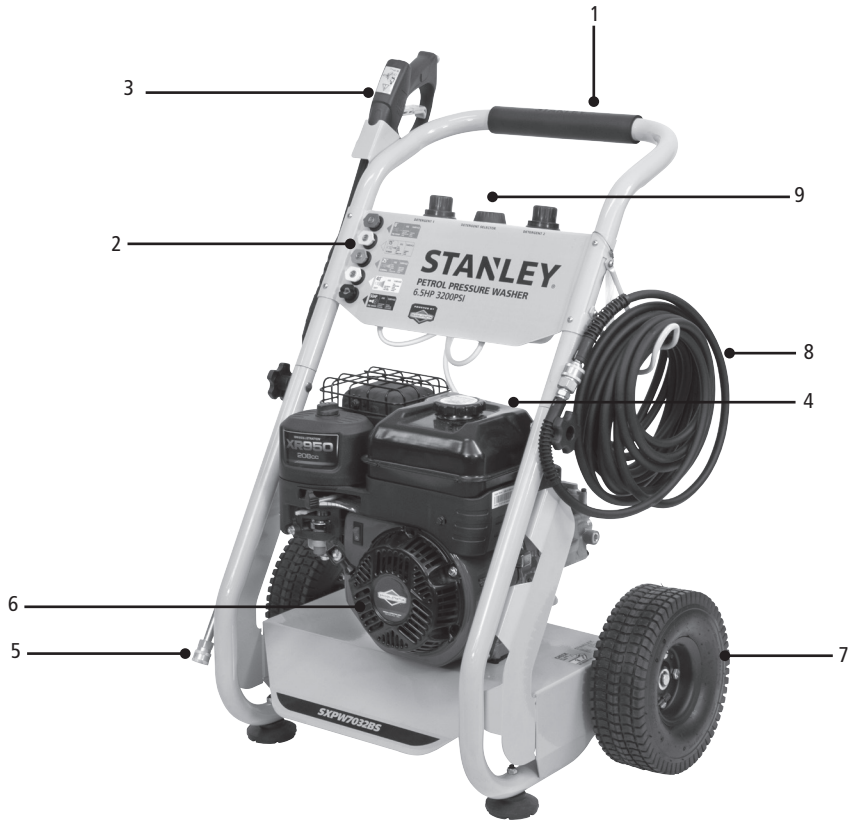

COMPONENTS AND CONTROLS

Pic. 1

1. Handle
2. Nozzles
 - RED - Pin Point
 - YELLOW - 15°
 - GREEN - 25°
 - WHITE - 40°
 - BLACK - Detergent
3. Gun and trigger
4. Fuel tank
5. Lance
6. Recoil Starter
7. Wheel
8. High pressure hose
9. Detergent controls

UNPACKING & ASSEMBLY

Unpacking

Note: Carefully unpack your pressure washer. This pressure washer is bulky and heavy, two (2) person lift required. Dispose of all packing material in an environmentally responsible manner.

Open carton, gently lift the pressure washer clear of the carton and packaging, this may require 2 people. Remove from plastic bag.

Note: Plastic bags can be a danger to young children, dispose of immediately. Always dispose of packaging in a responsible manner.

Wheels

Pic. 2

1. Place wheel on axle.
2. Slide the axle into the tube under the frame. Depress the brass button and push the axle into the tube.
3. Rotate the axle until the button "clicks" and locks into the hole in the tube.

Handle

Pic. 3

1. Align top handle to the main frame.
2. Insert bolt and tighten hand wheel.

Holders

Pic. 3

1. Align each holder(s) holes with those on handle.
2. Insert bolt and tighten.

Gun/Lance

Pic. 4

Push the lance into the gun and tighten nut. Slide cover over the nut.

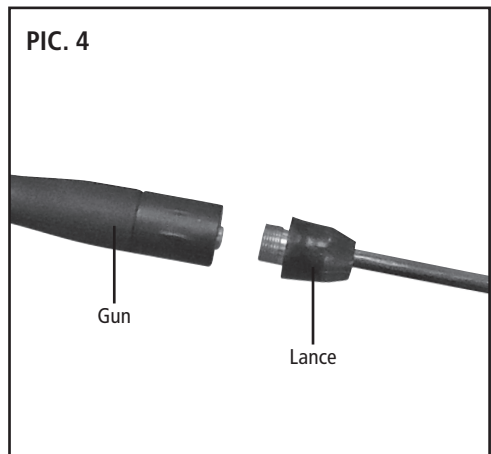
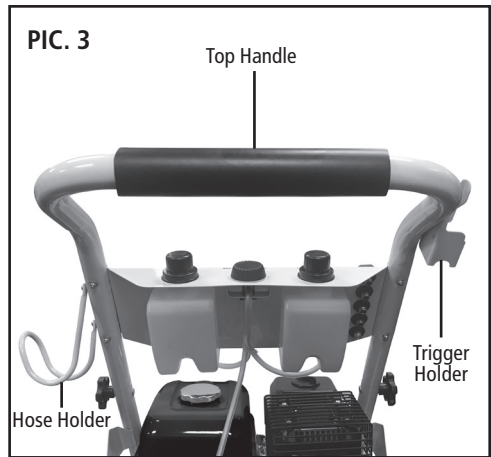
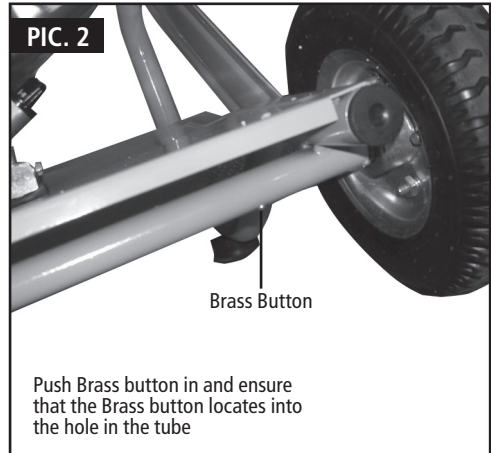

Hose to Pump

Pic. 5

1. Attach the high pressure hose to the pump. Pull back collar and push male connector in fully. Release collar. Ensure that the hose does not touch the muffler or goes over the top of the fuel tank.
2. Have hose lay to the back of the pump and curve to the hose hanger.

Note: Do not allow high pressure hose to touch the muffler. Damage will occur and will not be covered by warranty.

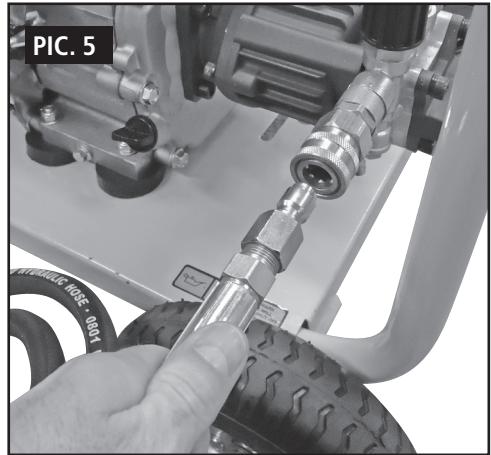

Pressure Hose to Gun Connection

Push hose fitting onto gun fitting and tighten nut fitting
To remove, loosen nut and remove hose.

Gun Safety Lock

Pic.6

To stop accidental use of the trigger, the gun is fitted with a safety lock.

To lock;

Push lever up.

To unlock;

Push lever down.

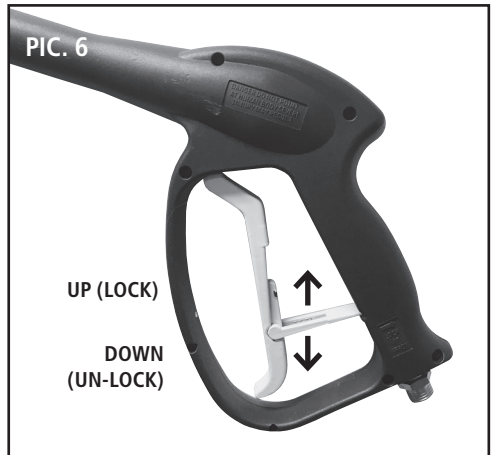

Garden Connection

Pic. 7

Screw black garden hose connection to pump

Dump Tube

Pic. 7

During times of no water flowing whilst motor is running, the pump will heat up. Periodically the pump will dump hot water through the tube to cool down.

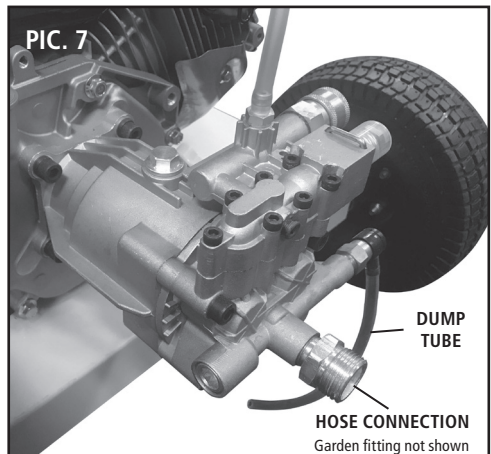

OPERATING INSTRUCTIONS

Pre - Operation Preparation

Note: If unit has previously been used, the motor, muffler and exhaust may still be hot enough to burn. Always exercise caution when checking the pressure washer.

1. Check that the fuel/engine switch is OFF.
2. Check that the spark plug lead is firmly attached to the top of the spark plug.
3. Holding on to the cage gently rock the pressure washer and listen for any noise which may indicate loose items. If anything appears to be loose either tighten or consult a service agent.

Filling the Fuel Tank

UNLEADED 91 PETROL - NO ETHANOL

Always use clean fresh fuel as specified on page 9. Stale fuel can cause the pressure washer to run rough and damage the motor; this will not be covered by warranty.

1. Ensure the engine is OFF.
2. Ensure the fuel tap and engine switch are both OFF.
3. Use fresh fuel as detailed on page 9.
4. Do not fill fuel tank above the top of the fuel filter, Pic. 8.
5. Ensure that the fuel tank cap is screwed on tightly.



WARNING

Fuel and its vapours are extremely flammable and explosive.

Fire or explosion can cause severe burns or death.

Always fill fuel tank outdoors or in well-ventilated area.

Keep fuel away from sparks, open flames, pilot lights, heat, and other ignition sources.

Check fuel lines, tank, cap, and fittings frequently for cracks or leaks. Replace if necessary.

If fuel spills, wait until it evaporates before starting engine.

Do not overfill fuel tank. Allow for expansion of the fuel and do not fill above the bottom of the fuel tank neck, Pic. 8.

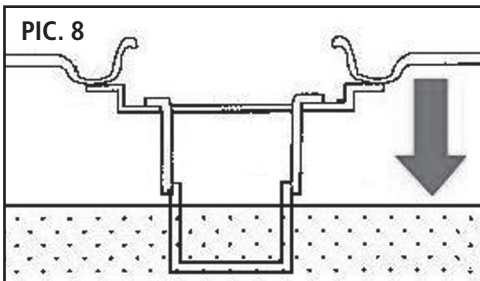

SELECTING NOZZLE

Black

This nozzle is for low pressure and for use with detergent tube and filter. Engine speed must be set on slow.

Red 0°

This nozzle is for high pressure and provides a single "pencil" stream of water.

Yellow 15°

This nozzle is for high pressure and provides a wide 15° "fan" of water.

Green 25°

This nozzle is for high pressure and provides a wide 25° "fan" of water.

White 40°

This nozzle is for high pressure and provides the widest 40° "fan" of water.

Connect / Disconnect Nozzles Pic. 9

Connect

1. Pull down QC collar
2. Push nozzle into hole
3. Release QC collar
4. Click nozzle into position

Note: If the nozzle remains loose or leaks check o-ring in end of lance. Replace if necessary, refer to "Trouble Shooting" on page 20.

Disconnect

1. Pull down QC collar
2. Lift nozzle out
3. Release QC collar

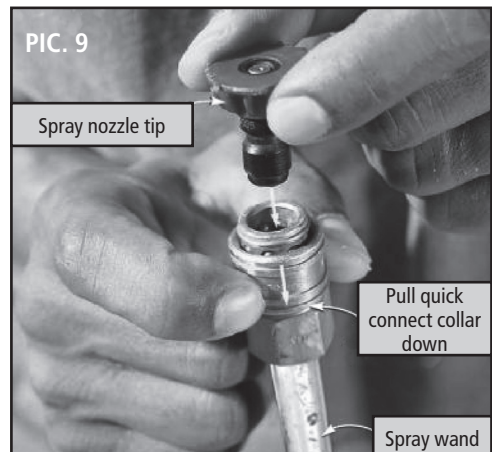

Adding Lubricating Oil

Always use clean fresh oil as specified on page 9. Incorrect or old oil can cause the pressure washer to run rough and damage the motor; this will not be covered by warranty.

1. Ensure that engine is OFF when filling oil.
2. Remove oil plug, see Pic. 9A
3. Use oil as detailed on page 9 (SAE 30W or SAE 15W-40 4 Stroke Motor Oil).
4. Ensure pressure washer is level when filling with oil.
DO NOT TIP / USE A FUNNEL (Not Supplied).
5. Only fill oil to the top of the thread, Pic. 9B.
6. Ensure that the oil filler cap is screwed on tightly before attempting to start the pressure washer.

Warning: Over filling the oil can damage the pressure washer, this damage will not be covered under warranty.

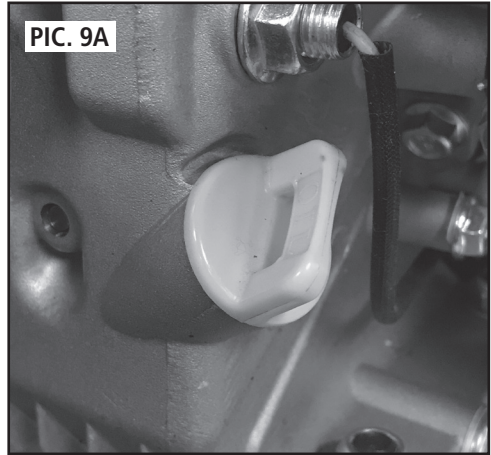

Detergent Tube and Bottles

Pic. 10

Connect the detergent tube, push the tube fully onto the nipple.

This model pressure washer comes with twin 800ml detergent bottles, you can use the same detergents in both or different ones in each.

Fill the detergent bottle/s and turn the selector to the bottle you wish to use.

Note: The detergent will only flow when the low pressure black nozzle is used and the motor speed is reduced.

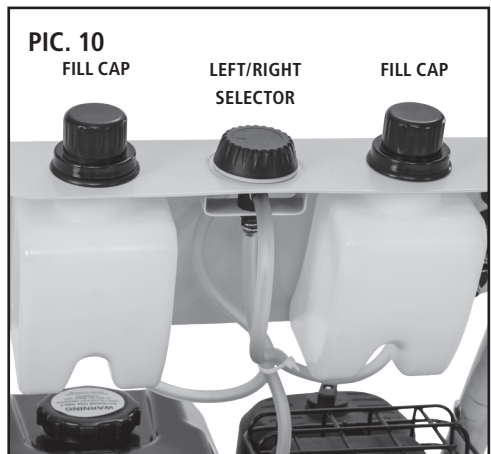
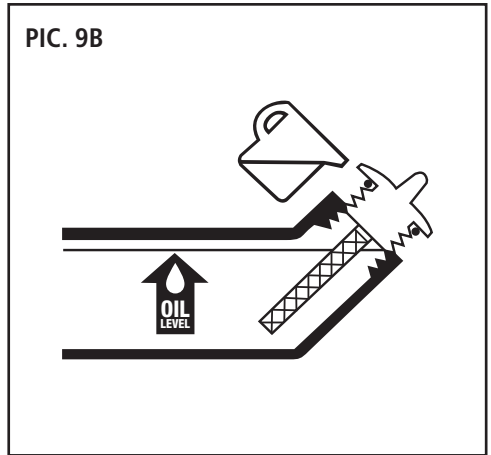

STARTING YOUR PRESSURE WASHER

1. Check oil level.
2. Check and fill fuel.
3. Connect garden hose to cold water source.
Do not turn on!
4. Connect garden hose to garden connection on pump.
5. Select nozzle, see page 13
6. If using detergent fill and select bottle refer page 14, Pic. 10.
7. Turn choke to start by sliding the choke lever to the LEFT, Pic 12.
8. Slide the fuel lever to ON by sliding the fuel lever to the right, Pic 11.
9. Push switch to "1", refer Pic. 13.
10. Pull the recoil starter slowly until engaged, then pull briskly. This step may need to be repeated until pressure washer engine starts, this can take up to about 12 pulls, Pic 14.

Warning: Never pull the recoil once the engine has started. Any damage caused will not be covered under warranty.

11. Once started turn choke to off (run), slide to RIGHT.
12. Turn cold water source on.
13. Release safety lock on trigger, push lever down.
14. Squeeze trigger on wand. Hold down until all air is purged and a steady stream of water is passing through, Pic 15.
15. Release trigger to stop water flow.

WHEN FINISHED WITH DETERGENT

When finished with detergent, release trigger on wand. Remove tube and filter from detergent bottle. Place tube and filter around handle. Do not place on the ground as this will suck dirt into pump. Any damage caused will not be covered under warranty.

Change nozzle, see page 13.

Squeeze trigger and continue cleaning with clean cold water.

STOPPING YOUR PRESSURE WASHER

To stop your pressure;

1. Turn cold water supply off.
2. Squeeze gun trigger, releases some water and pressure.
3. Turn fuel tap off.
4. Push engine switch off "0".
5. Once engine has stopped, squeeze gun trigger, releases some water and pressure.
6. Disconnect the garden hose from pressure pump and garden tap.
7. Lock the gun, push lever up.
8. Tidy up hose, gun and lance.
9. Allow pressure washer to cool about 1 hour before wiping down and store appropriately.

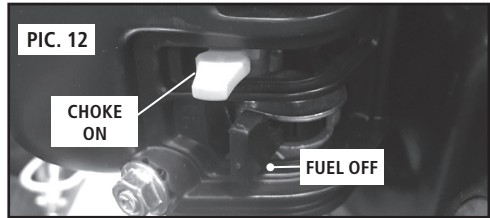
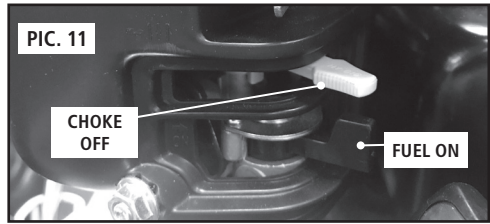

TAKING A BREAK DURING USE

If taking a break of more than 2 minutes during use you must turn the pressure cleaner off. Refer page 15 for how to do this.

Damage will be caused if the pressure washer is left running while the trigger is off and no water coming out for more than 2 minutes. Damaged caused will not be covered under warranty. Pressure washer pump may also “dump” hot water as a self preservation, when the pump temperature gets too hot during this break time.

NOZZLE CLEANING

Pic. 16

Clogging of the spray tip increases the water pressure and might damage the pump unit

- Clean the spray tip by carefully inserting the provided spray tip cleaner, or a thin, sharp object (e.g., paper clip) into the tip to remove deposits.

NOTE: If motor is labouring it is probably caused by a blocked nozzle. Clean nozzle as above.

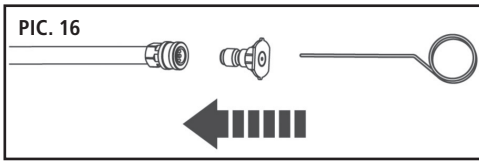

DRAINING THE TANK AND CARBURETTOR

PIC. 17

1. Turn ON fuel valve to make sure fuel is drained and the tank is empty. Residual fuel left over a long time will cause difficulty when next starting the engine.
2. Position an approved fuel container under the carburetor drain screw to catch fuel; loosen the bolt, Pic. 17. Allow fuel to drain completely into container.
3. Retighten drain bolt.
4. After draining the fuel tank and carburetor, start the engine and allow it to run until the unit runs out of fuel. Consult hazardous waste management guidelines in your area for the proper way to dispose of fuel.



CLEANING

NEVER use this pressure washer to clean itself. Damage caused by cleaning the pressure washer with its own gun will not be covered under warranty. Ensure pressure washer is cool before cleaning, about 1 hour after use.

- Wipe down all surfaces with a soft clean cloth.
- Rinse all nozzles in a bucket of clean water.
- Place in holder to dry.
- Ensure fuel tap is off.
- Ensure engine switch is off.
- Ensure high pressure hose is left wound up and not kinked.
- Store in a suitable area away from children or infirm persons.
- Store in a suitable area which will not freeze.

STORING

When storing for less than 4 weeks please follow these points to ensure no damage will occur to the pump or motor. Any damage caused will not be covered under warranty.

Start motor and run for no more than 30 seconds. This cleans the pump of excess water.

- Ensure the inlet water hose is not connected
- Ensure the high pressure hose is not connected to the pump
- Turn fuel tap on
- Turn choke lever to on (start)
- Insure speed lever is on high speed (rabbit)
- Push engine switch to 'on'
- Pull recoil
- Turn choke to off (run)
- Allow motor to run no more than 30 seconds
- Slide speed lever to slow (turtle)
- Turn fuel tap off
- Push engine switch off
- Drain fuel from tank and carburettor
- Clean as per “cleaning”

If the pressure washer is not to be used or is to be stored for more than one month the following storage procedure should be carried out. Drain all the fuel from the fuel tank and the carburettor, ensure that all the fuel has been drained.

Remove the spark plug and pour approximately one tablespoon full of clean engine oil into the spark plug hole.

With the ignition turned OFF gently pull on the recoil starter cord several times. Re-fit the spark plug and continue to pull the recoil starter cord until the piston is on the compression stroke (when resistance is felt) then stop pulling.

Store the pressure washer in a dry well ventilated place under a cover to prevent any dust or debris from accumulating on the pressure washer.

CLEANING TIPS

Deck Cleaning - with or without detergent

Pre-rinse deck and surrounding area with fresh water. If using deck wash, place detergent suction tube directly into cleaning solution and apply to surface at low pressure.

For best results, limit your work area to smaller sections of approximately 2m², allow deck wash to remain on surface 1-3 minutes. For stubborn dirt/stains you can use a patio cleaner head (not supplied).

Do not allow detergent to dry on surface.

Rinse at high pressure in a long sweeping motion keeping the spray nozzle approximately 75mm to 150mm from the cleaning surface. Always clean from top to bottom and from left to right.

When moving on to a new section of the cleaning surface, be sure to overlap the previous section to eliminate stop marks and ensure a more even cleaning result.

House Siding - with or without detergent

Pre-rinse cleaning surface with fresh water. If using house wash, place detergent suction tube directly into cleaning solution and apply to surface at low pressure (for best results, limit your work area to sections of approximately 2m wide and always apply detergent from bottom to top).

Allow house wash to remain on surface 1-3 minutes. Do not allow detergent to dry on surface, if surface appears to be drying, simply wet down surface with fresh water.

If needed, use special cyclone nozzle attachment (not supplied) to remove stubborn dirt. Rinse at high pressure from top to bottom in an even sweeping motion keeping the spray nozzle approximately 150mm from the cleaning surface.

Cement Patios, Brick & Stone - with or without detergent

Pre-rinse cleaning surface with fresh water.

If using all purpose cleaner, place detergent suction tube directly into cleaning solution and apply to surface at low pressure. For best results, limit your work area to smaller sections of approximately 2m². Allow all purpose cleaner to remain on surface 1-3 minutes.

Do not allow detergent to dry on surface.

Rinse at high pressure in a sweeping motion keeping the spray nozzle approximately 75mm to 150mm from the cleaning surface. Always clean from top to bottom and from left to right. For removing extremely stubborn stains, use dirt blaster nozzle.

Cars, Boats & Motorcycles - with or without detergent

Pre-rinse vehicle with fresh water. If using vehicle wash, place detergent suction tube directly into cleaning solution and apply to surface at low pressure.

For best results, clean one side of vehicle at a time and always apply detergent from bottom to top, do not allow detergent to dry on surface. Rinse at high pressure in a sweeping motion keeping the spray nozzle approximately 150mm to 200mm from the cleaning surface (distance should increase with in rinsing pin-striping or other sensitive surfaces).

Always clean from top to bottom and from left to right. For best results, wipe surface dry with a chamois or soft dry cloth.

BBQ Grills, Outdoor Power Equipment & Gardening Tools - with or without detergent

Pre-rinse surface with fresh water. If using all purpose cleaner or degreaser, place detergent suction tube directly into cleaning solution and apply detergent at low pressure. Allow detergent to remain on surface 1-3 minutes. Do not allow detergent to dry on surface

Rinse at high pressure keeping the spray nozzle approximately 75mm to 150mm from the cleaning surface. For removing extremely stubborn dirt, it may be necessary to move the spray nozzle even closer to the surface for greater dirt cutting action. To remove caked-on mud from garbage cans, lawn mower blades, wheelbarrows or other non-sensitive metal surfaces, you may want to use a smaller degree nozzle.

Patio & Outdoor Furniture - with or without detergent

Pre-rinse furniture and surrounding area with fresh water. If using all purpose cleaner, place detergent suction tube directly into cleaning solution and apply to surface at low pressure. Allow all purpose cleaner to remain on surface 1-3 minutes. Do not allow detergent to dry on surface. Rinse at high pressure in a sweeping motion keeping the spray nozzle approximately 75mm to 150mm from the cleaning surface. For best results, clean from top to bottom and from left to right.

Recommendations

If painted surfaces are peeling or chipping, use extreme caution as pressure washer may remove the loose paint from the surface.

Always start with the largest degree nozzle to minimise any paint damage.

MAINTENANCE INFORMATION

If scheduled maintenance is NOT carried out then this will void your warranty. Use the Service Log on page 22 to keep track of the regular servicing. Ensure that the authorised service agent has dated, signed and stamped this log to ensure your warranty is not void.

Fuel Tank Filter, Pic 18

The fuel tank filter should be checked every time you fill up the fuel tank. If dirty, replace. Your fuel tank filter should be replaced every 50 hours (operation) or every 3 months, whichever occurs first or whenever considered necessary.

To check or replace the fuel tank filter;

1. Remove the fuel tank cap.
2. Remove the fuel tank filter.
3. If dirty replace fuel tank filter before using the pressure washer.
4. Push new fuel tank filter into the top of the fuel tank.
5. Replace the fuel tank cap.

Spark Plug, Pic 19

Spark plug should be checked every 50 hours (operation) or every 3 months and replaced every 100 hours (operation) or every 6 months, whichever occurs first or whenever considered necessary.

1. Unplug the spark plug lead off the spark plug.
2. To clean use a wire brush/nail file and remove the carbon deposits on spark plug base.
3. Check the spark plug gap using a feeler gauge. The gap should be 0.7mm \approx 0.8mm (0.028" \approx 0.031").
4. The replacement spark plug is Champion RC12Y or QC12YC.

Air Filter

Air filter should be checked daily and replaced every 50 hours (operation) or every 3 months whichever occurs first or whenever considered necessary.

To check or replace the air filter;

1. Remove the air filter thumb nut and cover, see Pic. 20.
2. Remove air filter wing nut, washer and element.
3. If dirty, clean or replace air filter element before using the pressure washer.
4. Slide new air filter element onto the air filter box.
5. Replace air filter element, washer and wing nut.
6. Replace the air filter cover and thumb nut.

PIC. 18

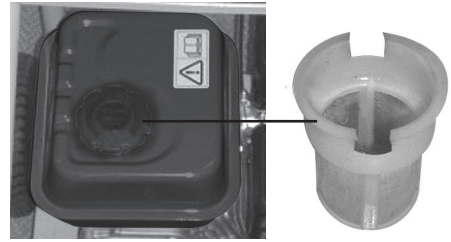

Fuel tank filter under fuel tank cap

PIC. 19

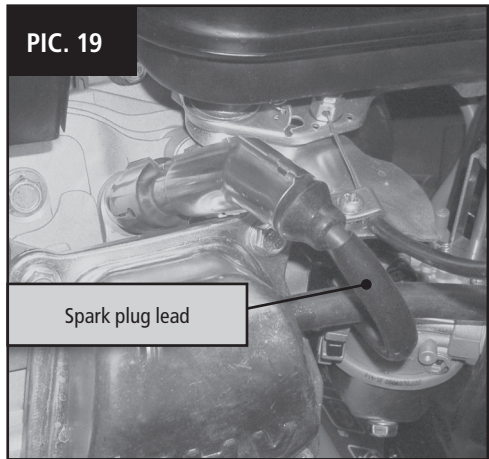

Spark plug lead

PIC. 20

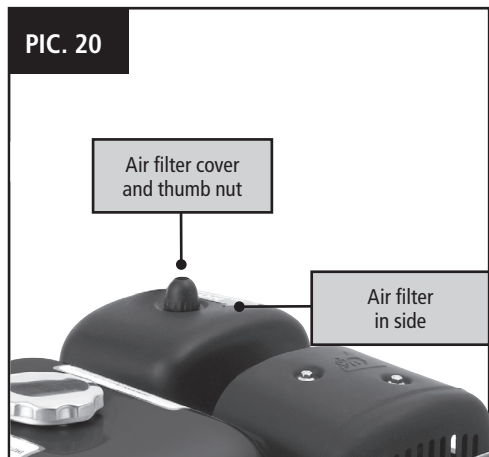

Air filter cover and thumb nut

Air filter in side

Engine

OIL (CHECK DAILY - ONLY USE 4 STROKE MOTOR OIL)

This pressure washer is fitted with a Briggs & Stratton engine. Please refer to the enclosed Briggs & Stratton Engine Manual for details on warranty and servicing.

To operate, this pressure washer requires oil in the sump, not supplied. If the pressure washer does not have the correct level of oil in the sump, it will not run, see note below.

Always check the oil level before starting the pressure washer.

Never check or add oil while the pressure washer is running.

Used oil is a hazardous waste product and must be disposed of properly. Do not discard with household waste. Check with your local authorities, service centre, or dealer for safe disposal/recycling facilities.

MAINTENANCE SCHEDULE

NOTE: If unsure how to do any of these checks please contact our service centre or an authorised service agent.

NOTE: When performing any maintenance or servicing always ensure the pressure washer is stopped and turned off.

Daily or Every 8 Hours

- Clean area around engine muffler and engine controls
- Clean engine air intake grill

Every 25 Hours or Every Month

- Clean engine air filter*
- Clean pre-cleaner, if equipped

Every 50 Hours or Every 3 Months

- Service exhaust system

Every 200 Hours or Annually

- Replace spark plug
- Replace engine air filter
- Replace pre-cleaner, if equipped
- Service fuel system
- * In dusty conditions or when airborne debris is present, clean more often.

Repairs

Repairs to your pressure washer should only be carried out by an authorised service agent.

Call SMG for your closest centre.

Aust. 1300 660 457 N.Z. 0800 474 876.



TROUBLE SHOOTING

POSSIBLE CAUSE	SUGGESTED FIX
Engine will not start	
No or low fuel in the fuel tank	Fill fuel tank
No or low oil in sump	Fill oil sump
Fuel/Engine lever is OFF	Turn fuel/engine lever ON
Choke is set to RUN	Slide choke to START
Pressurised pump	Turn water tap off, pull trigger to release water from pump. Start motor, then turn water tap on
Unit does not reach high pressure	
Diameter of garden hose is too small	Replace with a 12mm garden hose
Water supply is restricted	Check garden hose for kinks, leaks and blockage
Water inlet filter is clogged	Open water source to full force
Black detergent nozzle is attached	Remove detergent nozzle and attach a high pressure nozzle
Not enough inlet water supply	Check garden hose for kinks, leaks and blockage
Output pressure varies high and low	
Pump is sucking air	Check garden hose for kinks, leaks or blockage. Check whether hoses and fittings are air tight
Water inlet filter is clogged	Turn off machine and purge pump by squeezing trigger gun until a steady flow of water emerges through the nozzle
Discharge nozzle is obstructed	Remove filter and rinse out in warm water
Calcified gun, hose or spray wand	Blow out or remove debris with a fine needle. Run distilled vinegar through detergent suction tube
No detergent	
Detergent suction tube not properly connected to the machine	Check connection
Detergent is too thick	Dilute detergent
Garden hose connection leaks	
Filter on detergent suction tube is clogged	Run warm water through filter to remove debris
Damaged or clogged detergent suction tube	Remove obstruction or replace detergent suction tube
Spray wand leaks	
A high pressure nozzle is attached	Replace with black detergent nozzle
Discharge nozzle is obstructed	Blow out or remove debris with fine needle
Leaky connection	O-ring is worn, replace
Pump is noisy	
Loose fittings	Tighten fittings. Insert new washer. Ensure spray wand is tight onto the gun
Spray wand not properly attached	Tighten the spray wand onto the gun. Turn the wand collar clockwise onto the gun threads until tight
Water leaks from pump	
Pump is sucking air	Check whether hoses and fittings air tight. Turn off machine and purge pump by squeezing trigger gun until a steady flow of water emerges through nozzle
Loose fittings	Check that all fittings are tight
Oil Drop	
Oil seals are damaged or worn	Call service centre

PARTS DIAGRAM

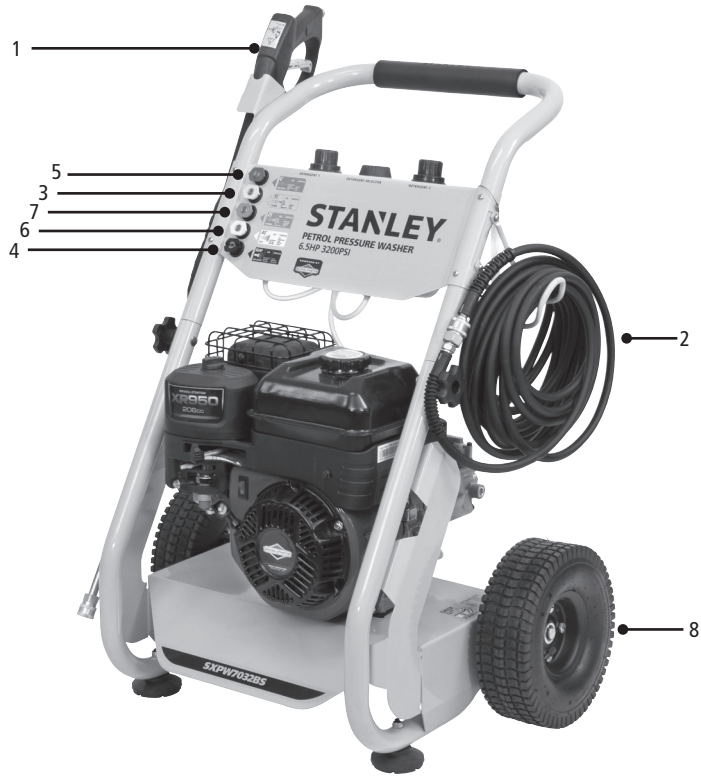

User replaceable parts listed below. All other parts must be serviced/replaced by an authorised service agent.

Part	Description	Part No.
1	Gun - trigger & Lance	84 PW5531GT
2	High pressure hose 10m QC	84 PW5531HPH
3	Nozzle yellow	84 PWN0Z
4	Nozzle black	84 PWN0Z
5	Nozzle red	84 PWN0Z
6	Nozzle white	84 PWN0Z
7	Nozzle green	84 PWN0Z
8	Wheel	84 PWWH

Note: Gun, trigger and lance are all one code (84 PW5531GT).

This Service is to be complete within 50 hours or 3 months of purchase, which ever comes first.

Replace	Check & Adjust
Air filter	Spark plug
Oil	
Authorised Service Agent (Name or Company Stamp)	
Technician	
Date	

This Service is to be complete within 100 hours or 6 months of purchase, which ever comes first.

Replace	Replace
Air filter	Spark plug
Oil	
Authorised Service Agent (Name or Company Stamp)	
Technician	
Date	

This Service is to be complete within 150 hours or 9 months of purchase, which ever comes first.

Replace	Check & Adjust
Air filter	Spark plug
Oil	
Authorised Service Agent (Name or Company Stamp)	
Technician	
Date	

This Service is to be complete within 200 hours or 12 months of purchase, which ever comes first.

Replace	Replace
Air filter	Spark plug
Oil	
Authorised Service Agent (Name or Company Stamp)	
Technician	
Date	

This Service is to be complete within 250 hours or 15 months of purchase, which ever comes first.

Replace	Check & Adjust
Air filter	Spark plug
Oil	
Authorised Service Agent (Name or Company Stamp)	
Technician	
Date	

This Service is to be complete within 300 hours or 18 months of purchase, which ever comes first.

Replace	Replace
Air filter	Spark plug
Oil	
Authorised Service Agent (Name or Company Stamp)	
Technician	
Date	

This Service is to be complete within 350 hours or 21 months of purchase, which ever comes first.

Replace	Check & Adjust
Air filter	Spark plug
Oil	
Authorised Service Agent (Name or Company Stamp)	
Technician	
Date	

This Service is to be complete within 400 hours or 24 months of purchase, which ever comes first.

Replace	Replace
Air filter	Spark plug
Oil	
Authorised Service Agent (Name or Company Stamp)	
Technician	
Date	

TECHNICAL INFORMATION

Specifications	
Pressure washer	SXPW7032BS
Maximum pressure	3200PSI
Flow rate	9L/min
Water inlet pressure	0.4MPa
Water inlet temp	35°C
Engine	6.5HP Briggs & Stratton 4 stroke OHV
Weight	35Kg (no fuel)
Fuel volume	3.1L
Oil	SAE 30W or SAE 15W-40
Oil Quantity	550ml
Spark Plug	CHAMPION RC12Y or QC12YC
Noise	102db @ 7m
Spark arrestor	Yes

For any queries or assistance call



Customer Service

AUST. 1300 660 457

NZ 0800 474 876

Hours of operation:

Monday to Friday 8.00am - 5.00pm AEST

Do not return to place of purchase.

Keep your purchase receipt, this will be required to make any claims under the warranty, stated on page 3.

STANLEY® **STANLEY®**

STANLEY®, The STANLEY Logo, The Notched Rectangle and the Yellow and Black Diagonal Package Design are all trademarks of the Stanley Black & Decker, Inc or an affiliate thereof and are used under license. Product manufactured and distributed by Smart Marketing Group Pty Ltd. Manufactured in China.