

GATOR

GTRACK4G

GPS TRACKER

PRODUCT USER MANUAL



Data Recording



Network



Wired

Introduction

Thank you for purchasing the GTRACK4G GPS Tracker. Please ensure that you have read the product manual and instructions in full, prior to installation and use. Failure to do so may result in product failure/damage or incorrect operation and therefore impact the product performance.

Product overview

The GTRACK4G GPS Tracker has been designed to offer an efficient, effective vehicle tracking system for managing your business fleet. A 3G/4G GPS tracking solution allows you to locate and track the whereabouts of your vehicle in real time via the Internet on a computer or Smartphone.

Product features:

- Built-in cellular and GPS antenna for easy installation
- 3G/4G compatible
- Requires active Text/Data Standard SIM card (Mobile SIM) not included
- Real-time tracking with history route
- Lithium-ion rechargeable battery
- 3 hour battery backup
- Built-in motion sensor
- Shock/displacement/ low battery/ power off/ over speed alert
- Main power cut off alert
- Power saving sleep mode
- Built-in motion sensor
- ACC detection
- Geo-fence capable
- Remote immobilization
- A-GPS locating (improves startup performance)
- Unit dimension 75x40x12mm
- Weight 39.5g

Table of contents

Introduction.....	p2
Product overview.....	p2
Product features.....	p3
Table of contents.....	p4
Package components.....	p5
Installation & setup.....	p6-9
Check list	p10-11
Function commands	p12-14
Download Smartphone App.....	p14
Login by Smartphone App.....	p15-16
Smartphone home screen.....	p17
Device list screen.....	p18
Historical route screen.....	p19
Geofence location screen.....	p20
Issue command screen.....	p21
Device screen.....	p22
Common command screen.....	p23
General command screen.....	p24
Alarm setting screen.....	p25
Login by Website.....	p26
LED indicator definition.....	p27
Trouble shooting guide.....	p28
Cautions.....	p29
Product specifications.....	p30-31
SIM card information.....	p32
APN settings.....	p33
Technical assistance.....	p34-35
IMEI/SIM card number safeguard.....	p36

1. GPS tracker
module



2. Relay
and harness

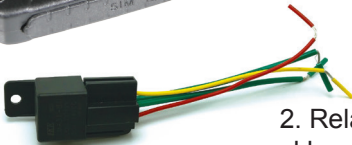

3. Power cable
with in-line
fuse



4. Adhesive
MountPad



Activation & Authorisation

1. Open the rubber plug, Insert an active Text/Data Standard SIM card that supports 3G/4G/GPRS network into the slot and make sure the chip side is up. **(Picture 1)**



2. Connect power cable and relay (optional) and follow wiring diagram

3. The GTRACK4G must know who you are and where to send alerts.

Set ADMIN number, by sending a SMS command to the SIM card inside your device.

For example:

admin123456 **XXXXXXXXXX**

(123456) is the default password.

XXXXXXXXXX is your mobile number.

NOTE: There is a space between password and mobile number.

GTRACK4G replies (**admin okay**).

4. Set APN number, by sending a SMS command to the SIM card inside your device.

APN123456 **SIMCARD PROVIDER**

(please use your local APN instead of CMNET (default), if you do not know the APN content you should contact your SIM card supplier).

For example:

apn123456 **xxxxxxxxxx**

(123456) is the default password.

xxxxxxxxxx is your mobile SIM card provider.

NOTE: There is a space between password and SIM card provider. For use in other countries replace the APN with the corresponding countries SIM card provider

5. Set the current time by sending a SMS command to the SIM card inside your device.

For example:

timezone123456 **+10**

(VIC daylight savings +10 hours ahead of GMT).

NOTE: There is a space between password and GMT time.

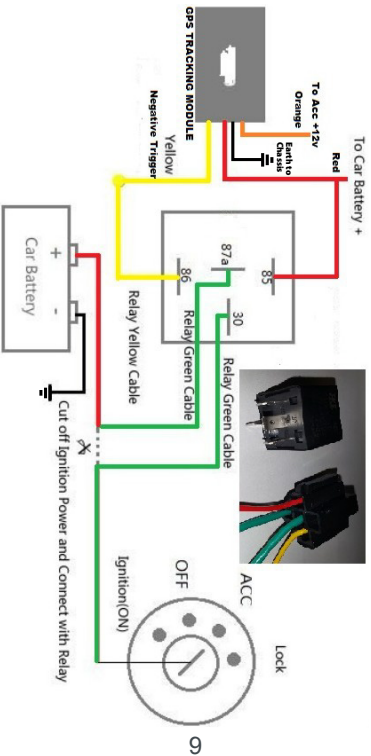

Check List

1. Sim card must have active service/ dial, minimum data of 2 gbs and sms.
2. Insert the Sim card contacts side up.
3. Plug power into the tracker module.
4. Make sure the red wire goes to the 12v battery and the orange wire goes to 12v accessory ignition.
5. Send sms command from your mobile phone to the tracker
“admin123456_(insert your mobile number here)” sms reply to your phone should be “admin ok”
6. Send sms command from your mobile phone to the tracker “apn123456_(insert your apn provider here)”
Optus is yesinternet
Telstra is telstra.internet
Vodafone is live.vodafone.com

SMS reply to your phone should be
“apn ok”

NOTE: 4g tracker will work with all providers.

This check list is important, if you type in the incorrect APN the device will not established a connection, the yellow led will not flash nor will it track.

7. Send sms command from your phone to the tracker “param1” sms reply should give details about the tracker.

e.g. imei number, internet provider and ip address this function will check if the parameters are correct.

8. Flashing yellow led is when the device is now communicating.

9. Blue flashing led has established a connection with the satellites.

Function commands

Function	Text to send to Gtrack4G	Reply
APN	apn+123456+space+SIM provider	apn ok
	apnuser+123456+space+SIM provider	apnuser ok
	apnpasswd+123456+space+ SIM provider	apnpasswd ok
admin number	admin123456+space+admin phone number	admin ok
time zone	timezone+123456+space+ GMT No.	timezone ok
time sleep	sleep123456 time	sleep time ok

shock sleep (default)	sleep123456 shock	sleep shock ok
no sleep	sleep123456 off	sleep off ok
upload frequency	upload123456+space+time	upload ok
Desired circuit to immobilise	555	Cut oil OK
Arm & Disarm	111 or SF	Arm delay in 0s
Position	G123456# or where	Google map

Restart	rst	restart ok
Back to factory	format	No reply

Downloading Smartphone APP

For iPhone: search “GTRACK” in the App Store to download

For Android: search “GTRACK” in the App Google play store to download

For further instructions of the Apps functionality, go to

www.tdj.com.au/help-downloads

and search for your product name

Log in by Smartphone APP

Log in by IMEI/ID

GATOR

GTRACK
GPS TRACKER

www.gtrack3g.com

IMEI/ID

Password

Remember login info

Login

Resume SMS

 Log in by username

 Log in by IMEI/ID

Log in by Smartphone APP

Log in by Username (pending)

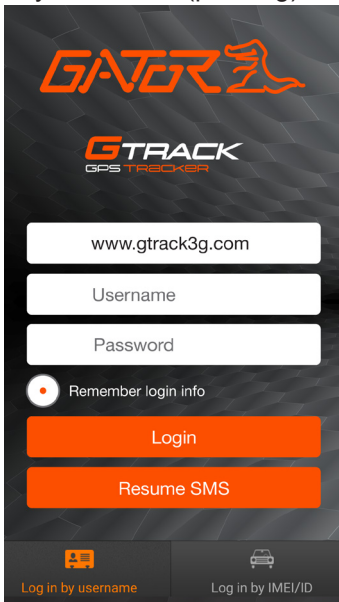

The screenshot shows the login interface for the GATOR GTRACK GPS TRACKER application. At the top, the GATOR logo is displayed in orange, followed by the GTRACK GPS TRACKER logo. Below the logos are three white input fields: the first contains the URL 'www.gtrack3g.com', the second is labeled 'Username', and the third is labeled 'Password'. A radio button is selected next to the text 'Remember login info'. Below these fields are two orange buttons: 'Login' and 'Resume SMS'. At the bottom, there are two options for login: 'Log in by username' with a person icon and 'Log in by IMEI/ID' with a car icon.

GATOR

GTRACK
GPS TRACKER

www.gtrack3g.com

Username

Password

Remember login info

Login

Resume SMS

 Log in by username

 Log in by IMEI/ID

Home screen

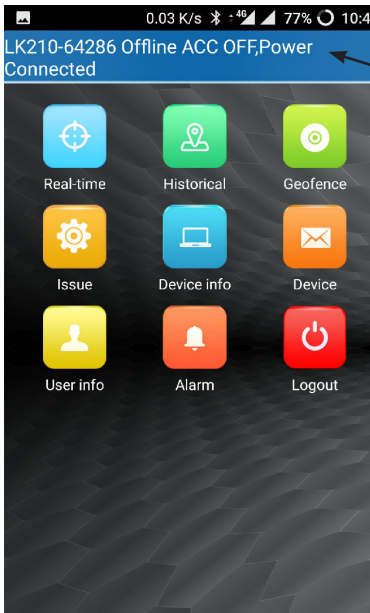

Device
status
info

Device List screen

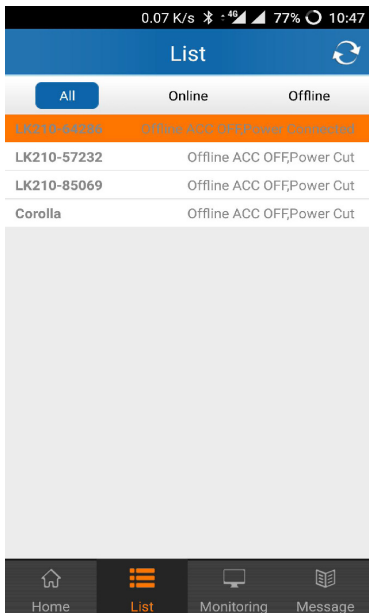

Historical route screen

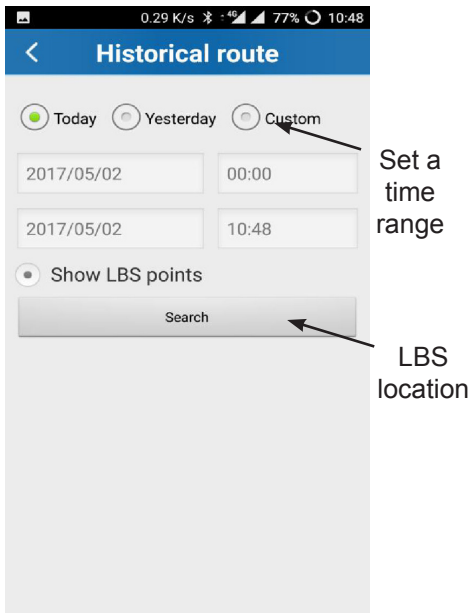

Geofence location screen



Issue command screen

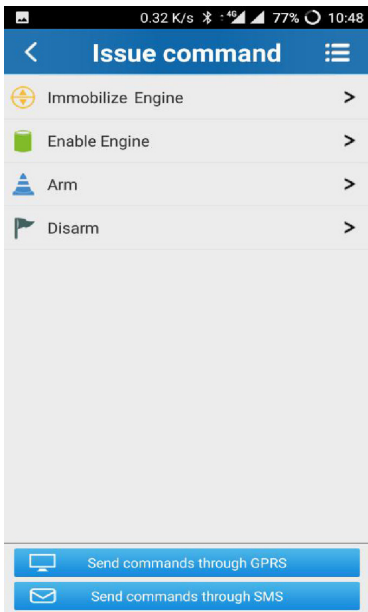

Device screen

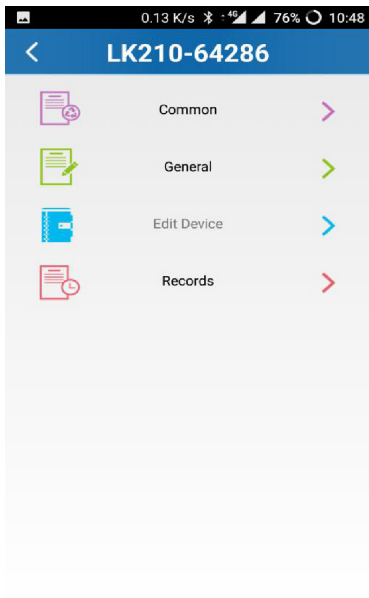

Common command screen

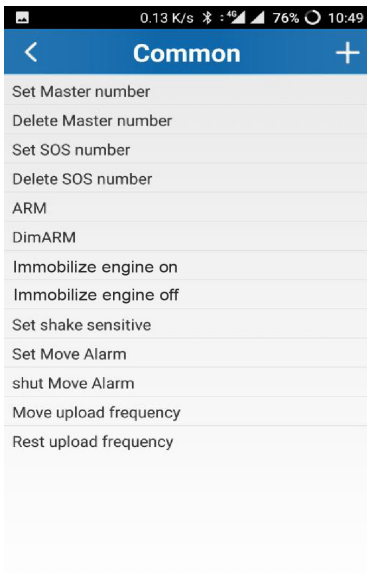

General command screen

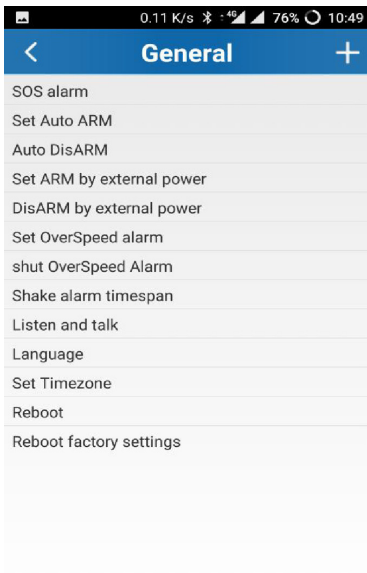

Alarm setting screen



Log in by website

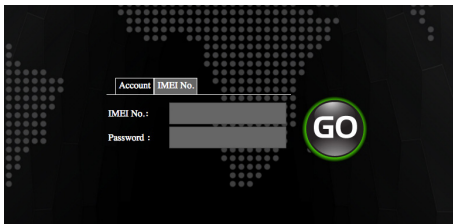

Open the website gtrack3g.com, choose IMEI No, enter the 10-digit ID code of the device, the default password is 123456, click “GO” to log in into the platform. IMEI number is printed on a sticker on the back of the unit.

Led indicator definition

Green Indicator: Mobile Network (3G/4G)

Status of indicator	Meaning
Flash	3G/4G conversation start
Solid	No 3G/4G signal
Off	Power off or in sleep mode

Blue Indicator: GPS

Status of indicator	Meaning
Flash	GPS location successful
Solid	Searching
Off	Power off or in sleep mode

NOTE: When the equipment in power saving sleep mode, the light will turn off after about 10 minutes (settable) without any operation.

Trouble shooting guide

Q: Start up Fail?

A: Check all wiring connections and fuses

Q: The device cannot obtain location information?

A: Place the unit in an open area to test.

Q: How to choose SIM card?

A: The SIM card must support 3G/4G & GPRS and ensure that the card has enough currency and credit.

Cautions

Please comply with the instructions to extend the unit life:

1. Keep the unit dry. Any liquid, i.e. rain, moisture, may destroy or damage the inside circuitry.
2. Don't use & store the unit in dusty places.
3. Do not place the unit in extremely hot or cold places
4. Handle carefully. Do not vibrate or shake it violently.
5. Clear the unit with a piece of dry cloth. Do not clean with chemicals or detergents.
6. Don't paint the unit, this may cause some foreign materials left in between the parts.
7. Don't disassemble or refit the unit.

8. Please use the battery and charger provided by manufacturer. Using other batteries and chargers will cause unwanted situation.

Product specifications

- Real-time tracking
- Vibration/Displacement/Low battery/
Power off/over speed alert
- Main power cut off alert
- ACC detection
- Geo-fence
- History Route
- Cut and resume functions remotely
- AGPS locating

Product specifications cont....

Frequency	WCDMA 850/900/1900/2100 MHz 3G/4G Version support
Backup Battery	3.7V 370mAh
Networks	WCDMA/GPRS
Operating voltage	9-75V
Location time	Cold start 35s-80s
	Hot start 1s
Location accuracy	5 meters
Operating temperature	-20°C~+55°C
Dimension	75*40*12mm
Weight	39.5g

SIM card information

3G/4G GSM TEXT & DATA Standard SIM CARD is required. It can be prepaid or plan, depending on usage usually \$5-\$10 per month is sufficient.

The GTRACK4G operating frequency is: WCDMA 850/900/1900/2100 MHz.

If the tracker is outside of this frequency range it will not work. For best coverage use Optus/Virgin & Vodafone. Telstra will only work in areas where the operating frequency is 2100MHz (generally built up/metro areas).

Depending on the network provider, you may need to first install the SIM Card into a mobile phone to receive the sim card activation sms. Please ensure the SIM Card is activated before installing it into the GTRACK4G. Ensure the SIM Card has sufficient TEXT & DATA credit.

APN settings

When configuring the GTRACK4G, you need to setup the mobile network APN (Access Point Name) to your GPS tracker (refer manual pg 7-8).

This is required to access the mobile data service by the tracker.

Your carrier APN is:

- ALDI Mobile: TELSTRA.INTERNET
- Amaysim: YESINTERNET
- Optus: YESINTERNET
- Telstra: TELSTRA.INTERNET
- TPG: YESINTERNET
- Virgin Mobile: VIRGININTERNET
- Vodafone: LIVE.VODAFONE.COM
- Kogan Mobile LIVE.VODAFONE.COM
- iiNET: YESINTERNET

If the APN / Service Provider is not listed above, please contact your Service Provider and ask for the APN.

Technical assistance

If you need assistance setting up or using your Gator product now or in the future, call Gator Support.

Australia

TEL: 03 – 8587 8898

FAX: 03 – 8587 8866

Mon-Fri 9am – 5pm AEST

Please retain this user guide for future reference.

If you would like to download a digital copy of this manual, or other Gator manuals/software, please visit the <http://gatordriverassist.com> website and click on ‘Firmware & Manuals’ This manual is considered correct at time of

printing but is subject to change. For latest manuals and updates refer to the website.

Copyright © 2017 by TDJ Australia
All rights reserved. No part of this publication may be reproduced, distributed, or transmitted in any form or by any means, including photocopying, recording, copying or other electronic or mechanical methods, without the prior written permission of the author.



IMEI/SIM number safeguard

Copy the IMEI/I.D. number (10-digit bar code of the device), and the SIM card number and place here for safe keeping before installing the device.

IMEI number

— — — — —

SIM number

Retailer

Date of purchase
