

BLACKRIDGE®

1700W Inverter Generator



 For service, spare parts or product information, please contact Smart Marketing Group Pty. Ltd.

AUST. 1300 660 457 N.Z. 0800 474 876

SUGGESTED APPLICATIONS

These are some suggestions of appliances which could be powered by this generator. These suggestions can not be run at the same time, please read page 11 for full details:

- Laptop computers up to 800W
- Televisions up to 175W
- DVD/Video players up to 500W
- TV and DVD/Video player combination up to 900W
- Camping fridges up to 200W
- Lighting up to 1250W
- Mobile phone/i pod/hand held games charging up to 1000W

Never exceed 1500W in total when using multiple devices.

CONTENTS

Section	Page
Contents	2
Suggested Applications	2
Introduction	3
Guarantee	3 – 4
General Safety Instructions	5 – 7
Specific Safety Instructions	8
Electrical Information	9
Fuel & Oil Information	9
Components and Controls	10
Operating Instructions	11 – 18
Maintenance	19 – 20
Trouble Shooting	21
Parts Diagram	22
Service Log	23
Technical Information	24
Contact Information	24

INTRODUCTION

Dear Customer,

Thank you for purchasing this generator which has passed through our extensive quality assurance processes. Every care has been taken to ensure that it reaches you in perfect condition. However, in the unlikely event that you should experience a problem, or if you require any assistance please do not hesitate to contact us;



If you have a problem, call customer service do not return this generator to the place of purchase.

CUSTOMER SERVICE

Australia: 1300 660 457

New Zealand: 0800 474 876

**Operating times: Monday – Friday
8.30am - 5.30 pm**

Australian Eastern Standard Time (AEST)

EXPRESS WARRANTY STATEMENT GENERATOR GROUP

You are not required to do anything to register your generator purchase. Please attach the purchase receipt to this manual and ensure both are kept safe. We hope you enjoy your new generator, and if you have any problems call customer service on the above phone numbers. Do not return to place of purchase.

Smart Marketing Group Pty Ltd (SMG) warrants that this generator will be free from manufacturing faults or defects for 12 months from the date of purchase, providing original purchase receipt is kept and shown when needed and is subject to the terms and conditions below.

If a warranty fault appears within the warranty period, SMG reserves the right to replace or repair the product. In the event that SMG chooses to replace the product, this original warranty will expire at the original date. If the product includes various accessories or components, only the defective accessory or component will be replaced or repaired.

SMG reserves the right to replace defective parts of the product with parts and components of similar quality, grade and composition where an identical part or component is not available.

Products presented for repair may be replaced by refurbished products of the same type rather than being repaired. Refurbished parts may be used to repair the products.

What is covered

- Manufacturing fault or defect.

How to claim under this warranty.

- Call customer service, phone number at the top.
- Ensure you have the following: Original purchase receipt, Model of generator, Serial number of generator.
- Discuss the issue.
- Customer service will advise which authorised service agent to take the generator to provided the issue is a warranty one.
- Take generator to authorised service agent for repair.

What is not covered

- Commercial use of generator.
- Use of generator in a commercial premises.
- Damage caused by incorrectly mixed 2 stroke fuel.
- Damage or deterioration due to transport.
- Damage caused by negligence, misuse, abuse or accident or incorrect voltage and wattage.
- Any corrosion or rusting.
- Damage caused by incorrect set up and start up.
- Replacement parts due to general wear and tear.
- Generators with serial number defacement, modification or removal.
- Generators which have been serviced by other than an authorised SMG service agent.
- Generators with no original purchase receipt.
- Generators which have been on sold, not original purchaser.
- Damage due non-servicing of generator as is required by this manual.
- Blockages / damage caused by dust, dirt, spiders webs or insects.
- Damage caused by the incorrect fitting of accessories.
- Damage caused by overloading, overworking the generator.
- Damage to attached equipment or third party accessories.
- Damage caused by attached equipment or third party accessories.

CONTACT DETAILS

Smart Marketing Group Pty Ltd
33-35 Lionel Road, Mt. Waverley
Victoria 3149, Australia.
Tel (+613) 9543 7266
Fax (+613) 9543 9839
sales@smga.com.au

COMPLETE WARRANTY STATEMENT – GENERATOR GROUP

As soon as you have purchased the generator, we recommend that you check to make sure it is intact and that you read the operating instructions carefully before using it. The purchase receipt for this product is to be retained and must be presented if making a claim under the terms of the Smart Marketing Group (SMG) warranty. Bank account statements are not acceptable for proof of purchase.

This warranty does not cover generators intended for hire or use in commercial applications or in commercial premises. The warranty will under no circumstances extend to reimbursement or payment of damages, whether direct, indirect or consequential. The warranty is void if there is evidence the generators has been modified or tampered with in any way or used with unauthorised accessories without our consent.

SMG declines any responsibility or liability whatsoever arising from misuse or abuse, negligent handling of the generators or if the product has not been installed or failure to comply with the relevant safety, operating, setting and maintenance instructions (see further in this manual).

The warranty does not extend to installation or disconnection costs.

Any item sent freight forward/collect for repair will be refused. Warranty repairs are free of charge, provided the appliance is delivered to our service department or authorised service agent. The generator will need to be returned, adequately protected in a box. SMG will not be responsible for any in-transit loss or damage. Assistance under the warranty will only be made available if the request is made to our customer service team on the contact numbers listed below and proof of purchase is provided.

This is a repair only warranty you will need to take the generator to the authorised service agent after contacting our customer service centre.

If the product includes various accessories or components, only the defective accessory or component will be replaced or repaired.

SMG reserves the right to replace defective parts of the product with parts and components of similar quality, grade and composition where an identical part or component is not available.

Products presented for repair may be replaced by refurbished products of the same type rather than being repaired. Refurbished parts may be used to repair the products.

Damage caused by third party accessories is not covered under this warranty.

Damage caused to attached equipment or third party accessories will not be covered under this warranty.

Rust and corrosion are not covered under this warranty.

If a warranty fault is found the freight cost will be credited to the owner. If no fault is found the product will be returned and any costs associated with the service will be charged to the owner.

Blockages caused by spider webs, insects, dirt, or accumulated dust and incorrectly mixed 2-stroke fuel are not covered by warranty. SMG reserves the right to replace or repair the appliance within the warranty period. Parts found to be defective due to a manufacturing default will be replaced free of charge.

In the event of SMG choosing to replace the appliance, the warranty will expire at the original date of purchase. If no warranty fault is found the owner will be advised and the product will be returned and any costs associated with the service will be charged to the owner.

Our goods come with guarantees that cannot be excluded under the Australian Consumer Law. You are entitled to a replacement or refund for a major failure and for compensation for any other reasonably foreseeable loss or damage. You are also entitled to have the goods repaired or replaced if the goods fail to be of acceptable quality and the failure does not amount to a major failure. The benefits of this warranty are in addition to any rights and remedies imposed by Australian State and Federal legislation that cannot be excluded.

In New Zealand, this SMG warranty is in addition to the conditions and guarantees which are mandatory as implied by the New Zealand Consumer Guarantee Act 1993. For service, spare parts or product information please contact customer service:

Australia: 1300 660 457

New Zealand: 0800 474 876

CONTACT DETAILS

Smart Marketing Group Pty Ltd
33-35 Lionel Road, Mt. Waverley
Victoria 3149, Australia.
Tel (+613) 9543 7266
Fax (+613) 9543 9839
sales@smga.com.au

SAFETY

Before attempting to operate this generator the following basic safety precautions should be taken to reduce the risk of fire, electric shock and personal injury. It is important to read the instruction manual and to understand applications, limitations and potential hazards associated with this generator. It is important that you read, understand and follow these instructions very carefully. They are designed for the safety of yourself and others ensuring a long and trouble free service life from your generator. This generator is not intended for use by persons (including children) with reduced physical, sensory or mental capabilities, or lack of experience and knowledge, unless they have been given supervision or instruction concerning the use of the appliance by a person responsible for their safety.

OPERATING ENVIRONMENT

ALWAYS use your generator in an open well ventilated area. Do not expose your generator to rain or use in damp or wet locations. Do not expose your generator to direct sunlight. Keep the work area well lit. Do not use your generator in areas where there is a risk of explosion or fire from combustible materials, flammable liquids, paint, varnish, petrol, etc flammable gases and dust of an explosive nature. As a precaution it is recommended that you consult an expert on selecting and using a suitable fire extinguisher and have it available for use in an emergency when operating the generator.

GUARD AGAINST ELECTRIC SHOCK

Never touch the generator with wet or damp hands as electric shock may occur. Always ensure your generator is connected to ground, i.e. Earthed with the supplied earth stake, see page 13.

BEWARE OF CHILDREN & PETS

Children and pets should be kept out of the operating area. Children should not be allowed to touch or operate generators or touch extension cords. All generators should be kept out of reach of children. When NOT in use keep the generator preferably stored or locked in a secure well ventilated cabinet or room with the fuel tank empty.

SELECT A GENERATOR WITH A SUFFICIENT RATING

Select the right generator for the job. Do not use a generator to do a job for which it was not designed. Do not force a small generator to do the job of a heavy duty generator. Any damage caused by overloading will void the warranty. Do not use generators for purposes not intended.

PROTECT POWER LEADS FROM DAMAGE

Always disconnect power cords from a power supply socket by pulling the plug. Never pull on the cord. Keep the power lead away from heat, oil, solvents and sharp edges. If a power lead becomes damaged have it replaced by an authorised service facility.

FUEL

Fuel used in this generator is poisonous. Always wear approved breathing protection when decanting fuel. If you get any fuel on your skin or clothes wash the affected area immediately with soap and water and change your clothes. If you get fuel in your eyes wash immediately with clean water and seek medical attention. If any fuel is swallowed DO NOT induce vomiting, seek immediate medical attention.

HOT COMPONENTS

Beware many of the components will get hot during use. Never touch any of the metal pipes, pump or motor as these may burn.

MAINTAIN YOUR GENERATOR WITH CARE

When not using your generator ensure the fuel cock is 'OFF'. Never leave the fuel cock 'ON' as this can damage the carburettor. Follow the instructions for lubricating and changing accessories. Keep handles clean, dry and free from oil and grease. Ensure that ventilation slots are kept clean and free from dust at all times. Blocked ventilation slots can cause overheating and damage to the motor. Ensure that the air and fuel filters are kept clean at all times.

REMOVE ADJUSTING KEYS AND WRENCHES

Form the habit of always checking to see that any adjusting keys or wrenches have been removed from the generator before operating.

FIRE PRECAUTIONS

Always contact your fire authority before using the generator on fire restricted days. It is not recommended to use your generator when a total fire ban is in force. Never refuel your generator while it is still running. Never connect your generator to a commercial or domestic power outlet. As a precaution it is recommended that an expert is consulted on obtaining and using a suitable fire extinguisher.

CLEANING YOUR GENERATOR

Always stop your generator before you commence cleaning. Always ensure that your generator has cooled, about one (1) hour, before cleaning and storing. When cleaning your generator use only a damp soft cloth. NEVER use liquid or solvents of any type.

EXTENSION CORDS & REELS

Inspect extension cords periodically and replace if damaged. Never use damaged extension cord as these may cause injury. Always unwind any extension cords fully before plugging into mains power supply. Protect your extension cord or reel from sharp objects, excessive heat, damp conditions or wet locations. Always use a '3' core extension cord or reel with this generator. Only extension cords intended for and marked 'outdoor' use, which are no longer than 10m.

GENERATOR 'EARTHING'

Always ensure that this generator is "Earthed" correctly before using. "Earthing" stake and wire has been supplied with this generator ensure it is used to ensure your safety, see page 13.

CHECK DAMAGED PARTS

Before using the generator it should be carefully checked to determine that it will operate properly and perform its intended function.

Check for broken or missing parts and have them replaced or repaired at an authorised service facility. Check any other condition that may affect the operation of the generator. A guard or any other part of the generator that is damaged should be properly repaired or replaced by an authorised service facility unless otherwise indicated in this instruction manual.

Any switch that does not operate correctly must be replaced by an authorised service facility.

DO NOT use the generator if the 'ON / OFF' motor switch does not turn the generator 'ON' and 'OFF'.

PERSONAL SAFETY

Clothing

Do not wear loose clothing, jewellery or anything that could get caught in moving machinery.

Hair

Long hair should be tied back or contained in a protective covering.

Eye Protection

The use of safety goggles is highly recommended (normal glasses are not sufficient for eye protection) when using or refuelling generators. Prescription glasses do not have safety lenses.

Footwear

Where there is the risk of heavy objects or if there is a risk of slipping on wet or slippery floors, suitable non-slip safety footwear should be worn. Protect your feet from dropping accidents.

Ear Protection

The use of ear protection is highly recommended when using generators. The continual noise may damage your ears.

Respiratory Protection

Always wear approved breathing protection when decanting fuel. ALWAYS use this generator in well ventilated area. Never use indoors.

WARNING: Do not breathe in exhaust fumes. Exhaust fumes are poisonous and may cause drowsiness, unconsciousness and even death.

Do Not Over Reach

Do not over reach. Keep a proper footing and maintain your balance at all times. Avoid using abnormal stances and awkward body positions.

Stay Alert

Watch what you are doing, use common sense, and never operate a generator when you are tired, drinking alcohol, taking drugs or if taking medication that causes drowsiness.



WARNING

Do not attempt to modify the generator in any way; this will VOID your warranty.

The use of any attachment or accessory other than those recommended in this instruction manual could result in damage to the generator and could cause injuries to the operator.

This petrol generator complies with Australian / New Zealand and International standards and safety requirements. Repairs should only be carried out by qualified persons using original spare parts. Failure to do so may result in considerable danger to the operator.

SPECIFIC SAFETY INSTRUCTIONS

Warning! Do not use the generator in areas where there is a risk of explosion or fire from combustible materials. The sparks possibly caused when using this generator may ignite combustible materials as well as flammable liquids, paint, varnish, petrol, flammable gases and dust of an explosive nature. As a precaution it is recommended that you consult an expert on a suitable fire extinguisher and its use. Ensure that the work area is kept clear of combustible materials.

Warning! Do not use the generator indoors or in confined spaces where exhaust gases, smoke or fumes could reach dangerous concentrations.

- Never connect this generator to a second generator.
- Never connect this generator to Commercial or Domestic power supply.
- Always use the generator in an open well ventilated area.
- Unit will become hot during use. Please keep generator at least one metre (1m) away from buildings, other equipment, pedestrian areas or flammable materials.
- Never pull the re-coil starter once the generator engine has started. Any damage caused will not be covered by warranty.
- Never start or stop the generator with any appliances attached.
- Ensure the generator has stopped before servicing, or lubricating etc.
- Do not attempt to modify the generator, guards or the supplied accessories in any way.
- Do not touch the exhaust. This can become very hot during operation and can cause serious burns.
- Always check the generator for damaged parts or fuel leaks, ensure these are fixed before using it.
- Never refuel while smoking or in the vicinity of an open flame.
- Always wear safety eye wear, ear and breathing protection when operating or refuelling the generator.
- To avoid a fire if you spill fuel while refuelling, clean up before starting the generator.
- Never operate or store the generator on its side, ALWAYS operate or store in an upright manner on firm, solid ground.
- Your generator is factory set, NEVER attempt to speed it up as this could endanger the user and damage the generator and/or attached appliances.
- Never operate the generator in damp, wet or flooded conditions.
- Before plugging appliances into the generator allow it to run up to full speed.
- If the generator makes an unfamiliar sound or vibrates excessively, switch the generator 'OFF' immediately. Investigate the possible cause or consult your authorised service agent.
- Do not use ANY type of coolant on the generator as a fatal electric shock could occur.
- Never use coolant in the generator as damage may occur.
- Do not touch the generator with wet hands as this may cause electrocution.
- Never use your generator on highly conductive surfaces e.g. Steel walk ways, metal roof or metal bench, as this could cause an electric shock.
- Always operate your generator at least two (2) metres away from conductive surfaces.
- Locate this generator in a convenient place, avoid using long extension leads.
- If an extension lead is used, avoid leaving it where it may be damaged by pedestrian or vehicular traffic or cause a trip and fall hazard.
- Always observe normal safety precautions with ALL appliances used with this generator.
- Never transport the generator with fuel in the tank. ALWAYS empty the fuel tank.
- All loads must be kept within the ratings stated on the name plate. Overloading the generator will damage the unit or shorten its life. This will not be covered under warranty.
- Do not tamper or alter any parts as this may cause personal injury or damage the generator.
- Always disconnect any loads before starting or stopping the generator.
- When storing the generator always store in a secure well ventilated area.
- Always store in an upright position. NEVER store or lay this generator on its side.

IMPORTANT



ELECTRICAL DATA

This generator is fitted with a sealed electrical connection socket that is compatible with the generator. If the electrical connection socket becomes damaged it must be replaced with a complete assembly that is identical to the original, and this must be replaced by an authorised service agent. Never connect to an external power supply. If in doubt always consult a qualified electrician.



FUEL - ONLY USE UNLEADED PETROL (ULP)

Fuel tank capacity – 3.5 litres (3.5 L)

Use of incorrect fuel and/or oil may damage the generator and will not be covered under warranty.

Do not use E10 or any type of ethanol fuel as this will damage the generator and will not be covered under warranty.

Do not use high octane fuels (greater than 91%) as this will damage the generator and will not be covered under warranty.

- Ensure you use clean fresh unleaded petrol (ULP).
- Use a clean approved container to store your unleaded petrol (ULP) in before decanting into the fuel tank.
- If contaminated (dirty) or old (stale) fuel is used any damage caused will not be covered under warranty.



OIL

To operate, this generator requires oil in the sump, not supplied. If the generator does not have the correct level of oil in the sump, it will not run, see note below.

Oil capacity – approximately four hundred millilitres (0.4 L or 400 ml)

Oil type – SAE 30W or SAE 15W-40

- Always check oil level before using.
- Always use fresh clean oil.
- Change oil every 50 hours or every 3 months.
- If contaminated (dirty) or old (stale) oil is used any damage caused will not be covered under warranty.

NOTE: This generator is fitted with an oil cut out switch and red warning light. If the oil level is empty or low then the generator WILL NOT start or run and the low oil light will glow when the recoil is pulled.

Always check the oil level before starting the generator.

Never check or add oil while the generator is running.

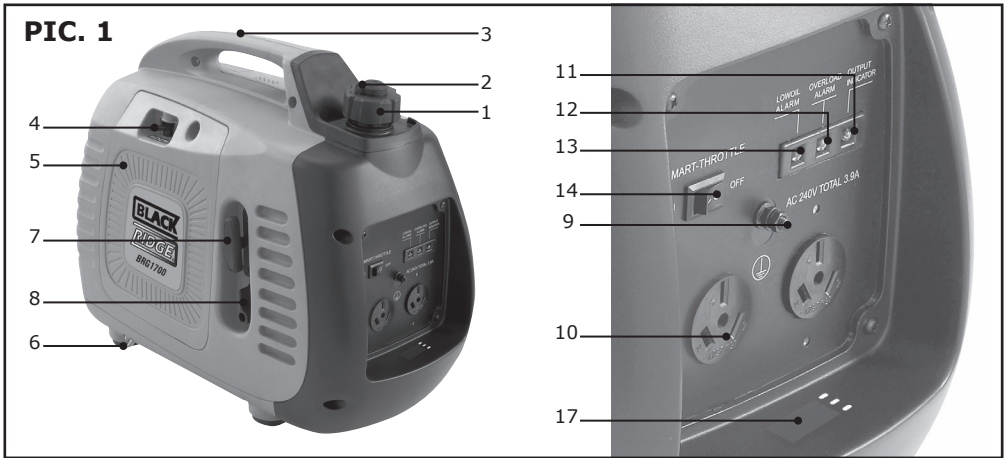

COMPONENTS AND CONTROLS

Pic. 1

- | | |
|---|---|
| <ol style="list-style-type: none"> 1. Fuel tank cap with pump 2. Fuel cap breather lever 3. Carry handle 4. Choke lever 5. Access panel 6. Over flow / drain tubes 7. Recoil handle 8. Fuel/Engine ON/OFF lever | <ol style="list-style-type: none"> 9. Earth lead attach point 10. 240V AC Power outlet sockets 11. Output power green light 12. Output power overload red light 13. Low oil red light 14. Smart throttle ON/OFF switch 15. "Earth" stake and wire, not shown 16. Oil fill bottle, not shown 17. Multi function meter |
|---|---|

OPERATING INSTRUCTIONS

Unpacking

Carefully unpack your generator. This generator is heavy (26.5Kg) and may require two (2) people to lift. Dispose of all packing material in an environmentally responsible manner.

Open carton, gently lift the generator clear of the carton and packaging, this may require 2 people. Remove from plastic bag.

NOTE: Plastic bags can be a danger to young children, dispose of immediately. Always dispose of packaging in a responsible manner.

Pre - Operation Preparation

Note: If unit has previously been used, the motor, muffler and exhaust may still be hot enough to burn. Always exercise caution when checking the generator.

1. Check that the fuel/engine switch is OFF
2. Check that the spark plug lead is firmly attached to the top of the spark plug.
3. Ensure that NO appliances are connected to the generator.
4. Holding on to the handle gently rock the generator and listen for any noise which may indicate loose items. If anything appears to be loose either tighten or consult a service agent

Filling the Fuel Tank

Always use clean fresh fuel as specified on page 8. Stale fuel can cause the generator to run rough and damage the motor; this will not be covered by warranty.

1. Ensure the engine is OFF.
2. Ensure the fuel/engine switch is OFF.
3. Use fresh fuel as detailed on page 8.
4. Do not fill fuel tank above the fuel filter, Pic. 2.
5. Ensure that the fuel tank cap is screwed on tightly.

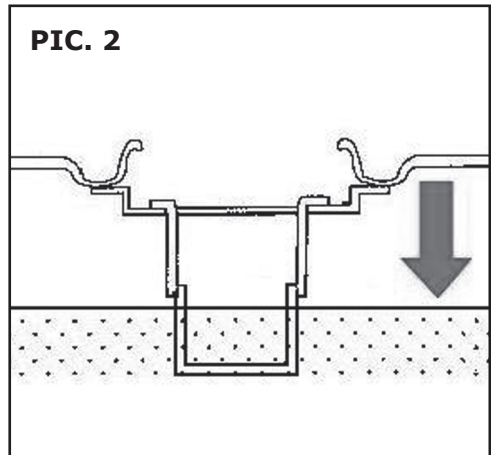

Adding Lubricating Oil

Always use clean fresh oil as specified on page 9. Incorrect or old oil can cause the generator to run rough and damage the motor; this will not be covered by warranty.

1. Ensure that engine is OFF when filling oil.
2. Remove access panel, Pic. 1, item 5, page 10.
3. Use oil as detailed on page 9.
4. Ensure generator is level when filling with oil.
DO NOT TIP.
5. Only fill oil to the top of the thread, Pic. 4.
6. Ensure that the oil filler cap is screwed on tightly before attempting to start the generator.

WARNING: Over filling the oil can damage the generator, this damage will not be covered under warranty.

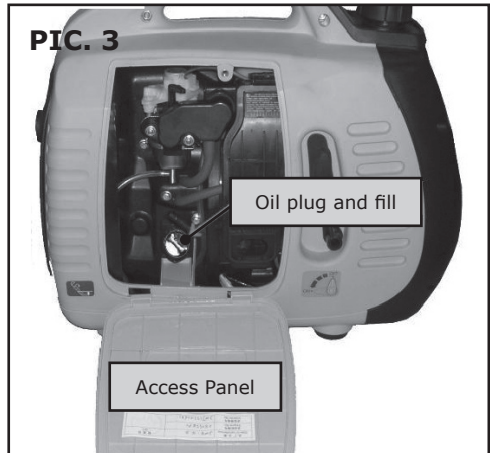

Multi Function Meter

Pic. 5

This digital meter will show the following:

- Voltage
- Hertz
- Kilowatts

These will rotate every few seconds whilst the generator is running. This display stops operating once generator is stopped.

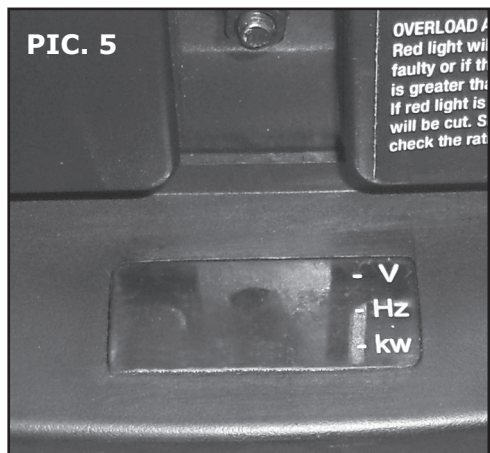
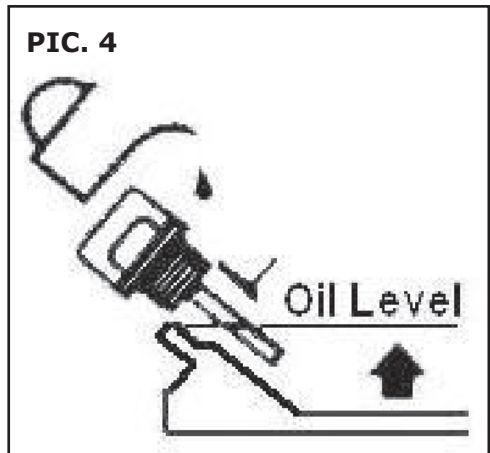

Generator 'Earthing'

Always ensure that this generator is "Earthed" **BEFORE** starting and using.

1. Ensure that engine is OFF when fitting the "Earth" stake and wire.
2. Attach the wire to the "Earth" point on the generator, see Pic. 6.
3. Push the attached stake into the ground. Ensure that this is not a trip hazard when near the generator.
4. Ensure the generator is OFF and cool before removing the "Earth" stake and wire.

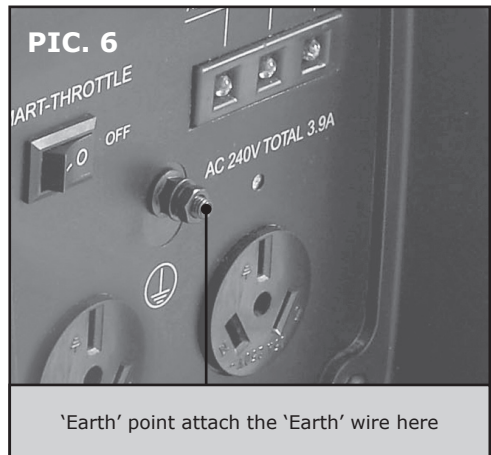

Starting Your Generator

Warning: Never start your generator without "earth" stake attached or with smart throttle ON or electrical appliances or power leads attached.

1. Ensure the "Earth" stake and wire are attached, see above.
2. Check that the smart throttle ON/OFF switch is turned OFF, Pic. 7.
3. Turn the fuel cap breather lever to ON, see Pic. 8.

NOTE: If you do not turn the fuel cap to ON your generator will stop.

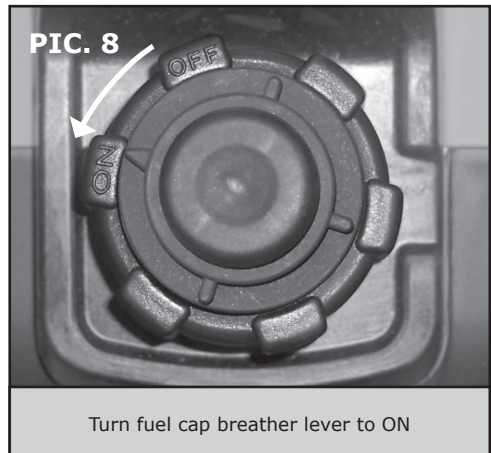
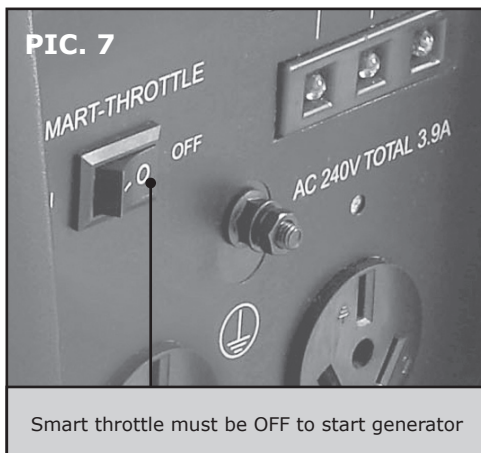

4. Lift pump up and push it down, repeat this 3 times, Pic. 9.
5. Turn choke to START by sliding the choke lever to the right, Pic. 10.
6. Turn the fuel/engine lever downwards to ON, Pic. 11.
7. Pull the recoil starter slowly until engaged, then pull briskly. This step may need to be repeated until generator engine starts, this can take up to about 12 pulls.

WARNING: Never pull the recoil once the engine has started. Any damage caused will not be covered under warranty.

8. Allow engine to run up to speed, this usually takes up to about 20 seconds.
9. Turn choke to RUN by sliding the choke lever to the left.
10. Check that the only illuminated light is the green output power. The generator will be idling and ready for use.

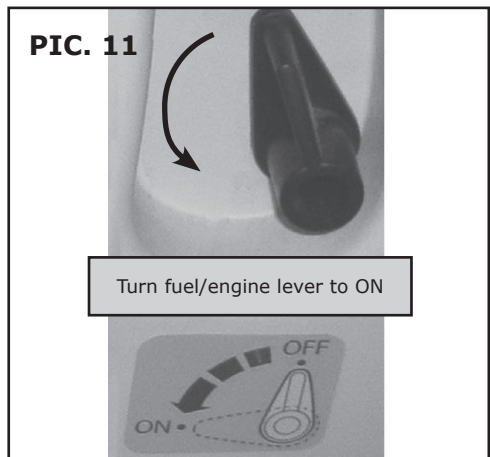
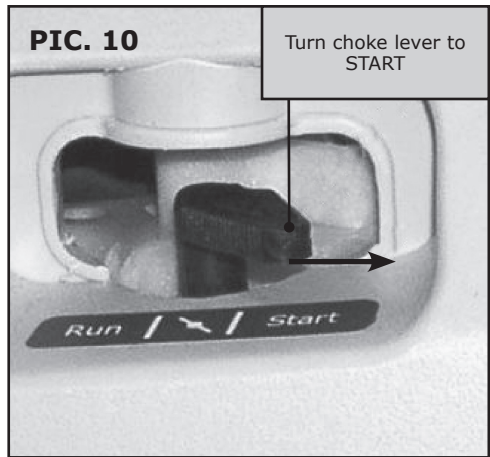
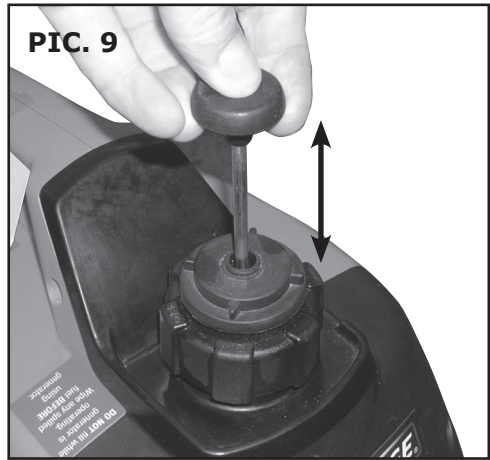

USING YOUR GENERATOR

AC Outlet

Your generator is equipped with dual 240V AC power sockets this will run a range of devices providing they are within the limits of the generators output.

NOTE: The peak (surge) power requirements of some devices e.g. Fridges, Televisions, etc; can be up to seven (7) times greater than their rated (continuous) power. Do not over load your generator. The devices wattage can be found on the data label, see Pic. 12.

You can use any combination of items provided that you do not exceed the limits of your generator. Never exceed 1500W in total when using multiple devices.

NOTE: When using multiple devices only start one device at a time.

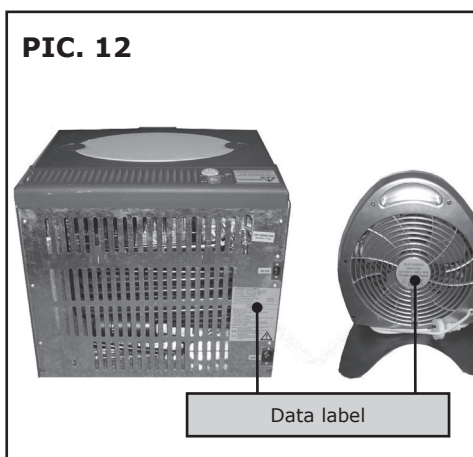

Your Generator AC Limits: Rated (continuous) power - 1700W Peak (surge) power - 1950W

Note: Long extension leads may reduce the effectiveness of your generators supply power.

To use the 240V AC outlet:

1. Check that the only illuminated light is the green output power. If not turn to page 16 and fix the problem before using the generator.
2. Lift the flap and plug your appliance into the outlet socket on the face plate.
3. Turn the appliance on and use as per the manufacturers manual.
4. When finished turn your appliance off.
5. Disconnect appliance from the generator and the flap should close automatically.

NEVER leave any appliances plugged into your generator, always disconnect when appliance is not in use.

Suggested Device	Maximum Suggested Wattage
Bayonet/Screw in globes (home use)	Up to 1400W Maximum of 28 x 50W globes
Florescent tubes	Up to 1200W Maximum of 50 x 20W globes
Halogen lights	Up to 1250W
Power tools	Up to 800W
Laptop computer	Up to 800W
DVD/Video players	Up to 500W
Portable television	Up to 175W
Portable television & DVD/Video combination player combination	Up to 900W
AC/DC camping fridge	Up to 200W
Cooling fans	Up to 800W
Heating	Up to 800W
Radio/CD player	Up to 1500W
ipod/MP3 player	Up to 1000W
Mobile phone charging	Up to 1000W
Hand held games charging	Up to 1000W

You can use any combination of items provided that you do not exceed the limits of your generator.
Never exceed 1500W in total when using multiple devices.

Output Power Overload Light

Once you have attached a device to the generator and turned it on, check to ensure that the output power overload light is NOT illuminated, see Pic. 13.

If the output power overload light stays illuminated STOP the device immediately.

This light is only illuminated if the attached device is faulty or if the devices required power is greater than the generators ability.

While the output power overload light is illuminated the output power green light will not illuminate.

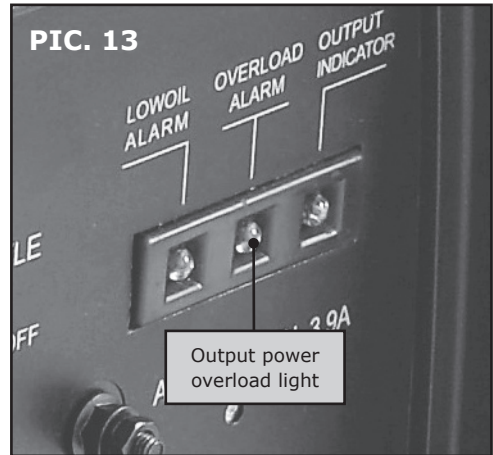

SAFETY DEVICES

AC Outlet

Your generator is equipped with an output overload light, see above. When this light is illuminated and the green output power light is out, then the generator will produce NO POWER.

To restart the power supply;

1. Remove the appliance.
2. Stop the generator, see page 17.
3. Wait 5 minutes.
4. Start generator, ensure the green output power light is the only light illuminated.
5. Re - attach the appliance.
6. If the output overload light becomes illuminated and the output power stops the attached appliance is either faulty or the appliances required power is greater than the generators output

Smart Throttle

Pic. 14

The smart throttle is designed to reduce the fuel consumption of the generator. By turning this switch ON you will reduce the speed of the engine and the generator. If a load is required the generator will automatically increase the speed of the engine and the generator.

Only turn the smart throttle ON when the generator has NO devices attached or if the devices wattage is below 600W.

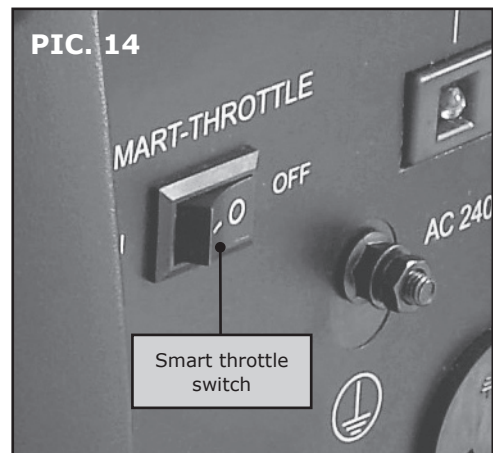

Low Oil Light

Pic. 15

If the oil level in the motor sump drops to a dangerously low level then the generator will automatically stop.

If the oil level in the motor sump is dangerously low, then the generator will not start, however the low oil light will flicker only when the recoil starter is pulled. If your generator will not start always check the oil level first.

Stopping Your Generator

Important: Before stopping the engine ensure ALL electrical appliances or power leads are unplugged from the generator.

Cooling Down

Allow your generator to idle, CHOKE OFF, NO LOAD and smart throttle ON for about 1 minute. This will allow all components to cool gradually and prolong the life of the generator.

To Stop

1. Turn off the appliance and disconnect from your generator.
2. Allow to cool down, see above.
3. Turn fuel/engine lever upwards to OFF.
4. Turn the fuel cap breather lever to OFF.
5. Remove the "Earth" stake and wire.

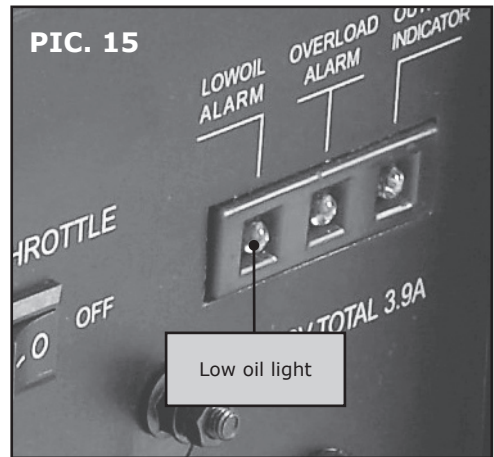

TRANSPORTING/STORING YOUR GENERATOR

Allow the generator to cool before transporting or storing.

1. **Warning:** Empty the carburettor bowl and turn the fuel cap breather OFF before transporting or storing.
2. To empty carburettor remove the access panel, Pic.1 Item 5, page 10.
3. Place a fuel resistant container under the discharge tubes, see Pic. 16.
4. Loosen the bowl screw, see Pic. 16.
5. Allow the fuel to drain into the container.
6. Tighten the bowl screw.
7. Appropriately dispose of the fuel.
8. Turn the fuel cap breather lever to OFF, see Pic. 17.
9. Re-fit the access panel.

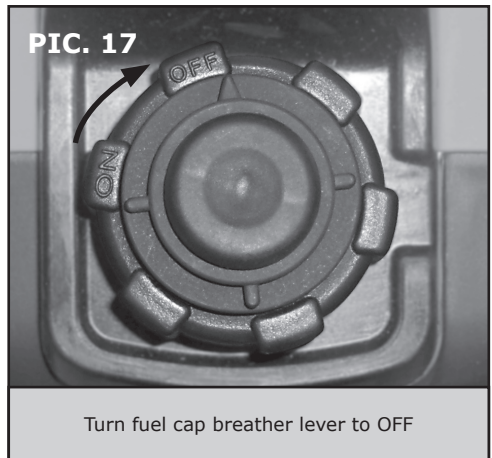
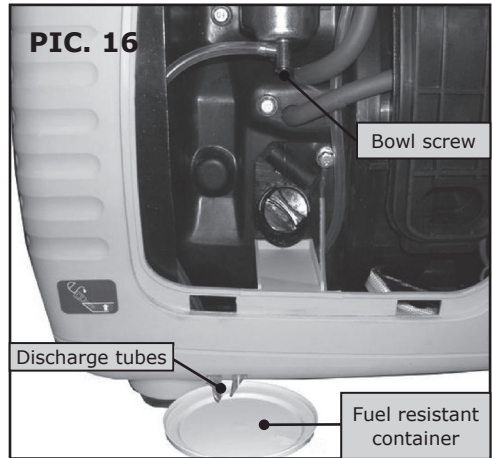

MAINTENANCE INFORMATION

If scheduled maintenance is NOT carried out then this will void your warranty. Use the Service Log on page 23 to keep track of the regular servicing. Ensure that the authorised service agent has dated, signed and stamped this log to ensure your warranty is not void.

Fuel Tank Filter, Pic. 18

The fuel tank filter should be checked every time you fill up the fuel tank. If dirty, replace. Your fuel tank filter should be replaced every 50 hours (operation) or every 3 months, whichever occurs first or whenever considered necessary.

To check or replace the fuel tank filter;

1. Remove the fuel tank cap.
2. Remove the fuel tank filter.
3. If dirty replace fuel tank filter before using the generator.
4. Push new fuel tank filter into the top of the fuel tank.
5. Replace the fuel tank cap.

Fuel Line Filter

The fuel line filter should be replaced every 50 hours (operation) or every 3 months, whichever occurs first or whenever considered necessary. This must be replaced by an authorised service agent.

This servicing must be carried out as noted above or your warranty will be void.

Spark Plug

Spark plug should be checked every 50 hours (operation) or every 3 months and replaced every 100 hours (operation) or every 6 months, whichever occurs first or whenever considered necessary.

1. Slide the plug panel off the generator, Pic. 19.
2. Unplug the spark plug lead off the spark plug; Pic. 20.
3. To clean use a wire brush/nail file and remove the carbon deposits on spark plug base
4. Check the spark plug gap using a feeler gauge.
The gap should be 0.6mm \approx 0.7mm (0.024" \approx 0.028")
5. The replacement spark plug is Torch A7RC or NGK CR7HSA

PIC. 18



PIC. 19

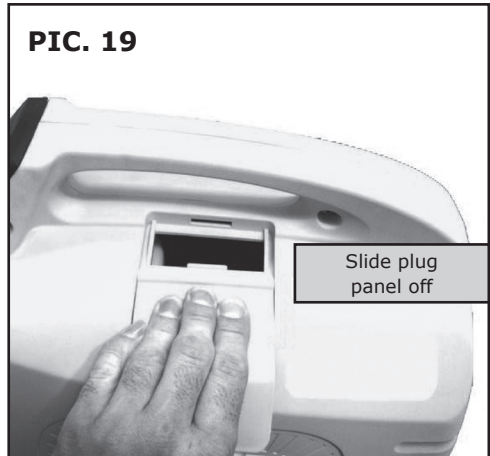

PIC. 20

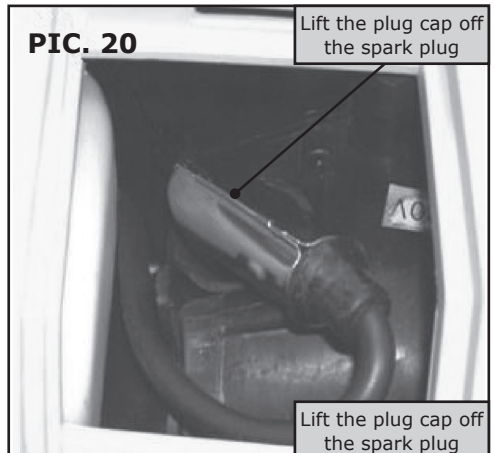

Air Filter

Air filter should be checked daily and replaced every 50 hours (operation) or every 3 months whichever ever occurs first or whenever considered necessary.

To check or replace the air filter;

1. Remove the access panel.
2. Remove the air filter cover, see Pic. 21.
3. Remove air filter element.
4. If dirty clean or replace air filter element before using the generator.
5. Push new air filter element into the air filter box.
6. Replace the air filter cover.
7. Replace the access panel.

Oil

Oil should be checked daily and replaced every 50 hours (operation) or every 3 months whichever ever occurs first or whenever considered necessary, see Pic. 22.

To check or change oil;

1. Remove access panel.
2. Remove oil plug and check oil level, refer page 10 for oil level. Top up if required.
3. To change oil do steps 1 and 2 then pour old oil into a suitable container and dispose of in an environmentally responsible manner.
4. Fill with clean fresh oil as per page 9.
5. Check oil level as per page 12.
6. Fit and tighten the oil plug and access panel.

Cleaning

ENSURE the generator is NOT running whilst cleaning. To keep the generator clean, always wipe down after use. Wear eye protection when cleaning. Only clean the generator with a damp soft cloth. NEVER use liquid or solvents of any type. Ensure ventilation slots are kept clean and free from dust/dirt build up.

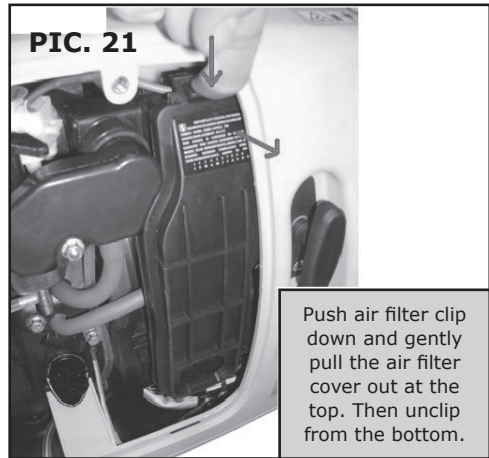



TROUBLE SHOOTING

Engine will not start	
Possible Cause	Suggested Fix
No or low fuel in the fuel tank	Fill fuel tank
No or low oil in sump	Fill oil sump
No fuel in carburettor	Prime tank
Fuel/Engine lever is 'OFF'	Turn fuel/engine lever 'ON'
Choke is set to 'RUN'	Slide choke to 'START'
Possible no spark	Check/replace spark plug
Generator is loaded on start up	Remove appliance from generator
Engine will not run	
Possible Cause	Suggested Fix
Fuel cap breather lever is OFF	Turn fuel cap breather lever to ON
Choke is set to START	Turn choke to RUN
No AC electrical output	
Possible Cause	Suggested Fix
Output power overload activated	Stop generator, refer to page 17
Faulty power cord on device used	Replace cord on device being used
Faulty power socket	Have service agent replace socket
Generator overheating	
Possible Cause	Suggested Fix
Insufficient ventilation	Check and clean ventilation slots. Move to a more adequate supply of fresh air

Repairs

Repairs to your generator should only be carried out by an authorised service agent.

Call BLACKRIDGE for your closest centre, Aust.

Aust. 1300 660 457 N.Z. 0800 474 876.

PARTS DIAGRAM

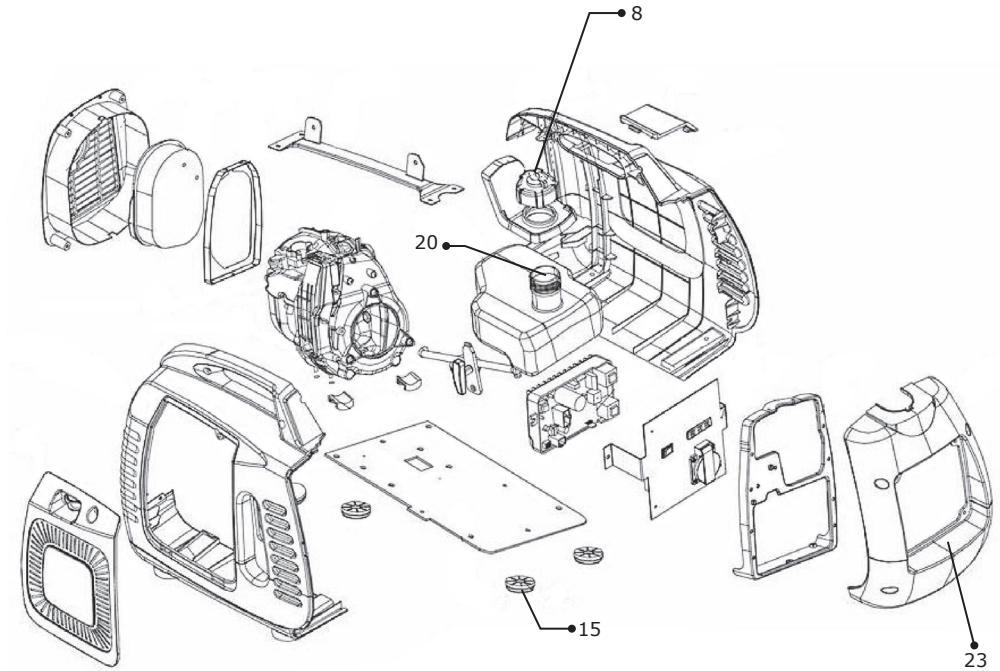

User replaceable parts listed below. All other parts must be serviced/replaced by an authorised service agent.

Part	Description	SMG Part No.
20	Fuel tank filter for pump	84 BRG1700TFF
8	Fuel tank cap with pump	84 BRG1700FCP
15	Rubber feet	84 BRG1700RF
	Spark plug	84 BRG1700SP
	Air filter element	84 BRG1700AF
	Socket	800-2-016
	Oil bottle (empty)	800-2-018
	Earth stake and lead	2500-1-035
23	Multi function display	84 BRG1700MFD

SERVICE LOG

Purchase Date _____

Place of Purchase _____

This Service is to be complete within 50 hours or 3 months of purchase, which ever comes first.

Replace	Check & Adjust
Fuel tank filter	Spark plug
Fuel line filter	
Air filter	
Oil	
Authorised Service Agent (Name or Company Stamp)	
Technician	
Date	

This Service is to be complete within 100 hours or 6 months of purchase, which ever comes first.

Replace
Fuel tank filter
Fuel line filter
Air filter
Spark Plug
Oil
Authorised Service Agent (Name or Company Stamp)
Technician
Date

This Service is to be complete within 150 hours or 9 months of purchase, which ever comes first.

Replace	Check & Adjust
Fuel tank filter	Spark plug
Fuel line filter	
Air filter	
Oil	
Authorised Service Agent (Name or Company Stamp)	
Technician	
Date	

This Service is to be complete within 200 hours or 12 months of purchase, which ever comes first.

Replace
Fuel tank filter
Fuel line filter
Air filter
Spark Plug
Oil
Authorised Service Agent (Name or Company Stamp)
Technician
Date

TECHNICAL INFORMATION

Specifications	
Generator	BRG1700
Output Voltage	240V AC ~ 50Hz
Continuous Power (Rated)	1700W (7.0 Amps)
Maximum Output	1.7Kva at power factor of 1
Peak Power (Surge)	1950W
Inverter	Yes
Motor	Single cylinder 4-stroke
Spark Arrestor	Yes
Tank Capacity	3.5L
Noise Level	68db at 7m
Weight	26.5Kg (no fuel)
Approximate Run Time	4 Hours at 900W
Fuel	Unleaded Petrol
Oil	SAE 30W or SAE 15W-40
Oil Quantity	400ml
Spark Plug	Torch A7RC or NGK CR7HSA

For any queries or assistance call



Customer Service

AUST. 1300 660 457

NZ 0800 474 876

Hours of operation:

Monday to Friday 8.30am - 5.30pm AEST

Do not return to place of purchase.

Keep your purchase receipt, this will be required to make any claims under the 12 month warranty.

Blackridge® is a registered trademark of Smart Marketing Group Pty Ltd

BLACKRIDGE®