

## CALIBRE 12 INCH THERMO FAN

PLU	Size	Air Flow	Amps	Voltage
119181	12"	Push	8.0±1.0	12

### Dimensions

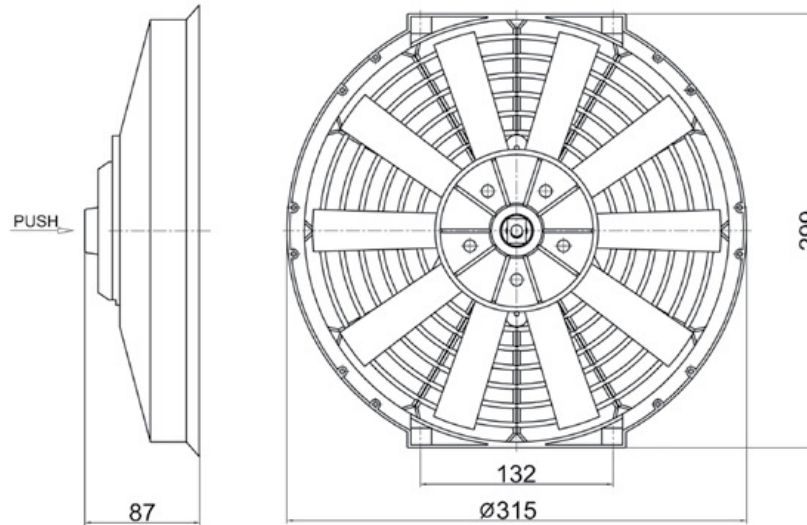

### Volume Flow

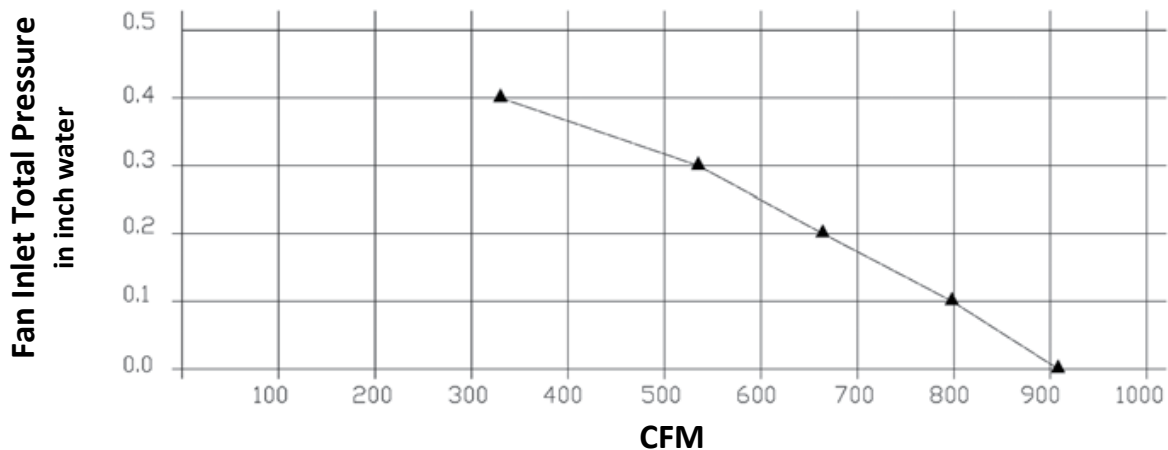

### Model Comparison

PLU	Size	Air Flow	Amps	Voltage	Height, total (mm)	Width, total (mm)	Depth, total (mm)	Approx. Max CFM
119180	10"	Push	7.5±1.0	12	292	277	60	725
119181	12"	Push	8.0±1.0	12	299	315	87	910
119182	14"	Push	10.5±1.0	12	340	356	86	1230
119183	16"	Push	13.6±1.0	12	428	405	100	1670